

corrateg
PASSION OF CYCLING

ORDERBOOK **2024**

IN DE XX



VORWORT	4	PROLOGUE
UNSERE WERTE	6	OUR VALUES
HISTORIE	8	HISTORY
AUSZEICHNUNGEN	12	AWARDS
TEAM CORRATEC	14	TEAM CORRATEC
MTB RACINGTEAM	18	MTB RACINGTEAM
CORRATEC USA	20	CORRATEC USA
SIEGE	22	VICTORIES
DAS NEUE CCT EVO	26	THE ALL NEW CCT EVO
SHADOW EDGE 3.0	32	SHADOW EDGE 3.0
PARTNER	36	AMBASSADORS
WAS IST DEINE MISSION?	38	WHAT'S YOUR MISSION?
EINSATZBEREICHE	40	RANGE OF USE
TECHNOLOGIEN	42	TECHNOLOGIES
E-BIKE	44	E-BIKE
ROAD	124	ROAD
GRAVEL	138	GRAVEL
MOUNTAINBIKE	154	MOUNTAINBIKE
CITY & TREKKING	178	CITY & TREKKING
KLEIDUNG	190	CLOTHING
RAHMEN	200	FRAMES





Konrad Irlbacher

Gründer und Firmenchef
Owner and CEO

Cielo Irlbacher

Firmenchefin
CEO

Wir leben in einer Welt der Veränderungen, an die wir uns tagtäglich anpassen müssen. Der Wandel der Zeit treibt unser Denken und unser Handeln stetig an und stellt uns immer wieder vor neue Herausforderungen. Die Marke corratec steht seit über 30 Jahren für Innovation, Qualität und modernes Design, das sich in unseren Produkten widerspiegelt. Wir sind sehr stolz, Ihnen als unsere wichtigsten Partner, dieses Jahr eine Bike Range der Superlative mit zahlreichen Innovationen und einer Weltneuheit in der urbanen Mobilität zu präsentieren. In jedem einzelnen Produkt steckt 100% Leidenschaft, Perfektion und modernste Technologie – made in Germany, hier in Raubling am Fuße der Alpen. Gemeinsam werden wir Ihre Kunden begeistern.

We live in a world full of changes that we have to adapt to every day. These changing times constantly drive our thinking and our actions, and present us with new challenges time and time again. For more than 30 years now, the corratec brand has been synonymous for innovation, quality and modern design, which is reflected in all our products. We are very proud to present you with an outstanding range of bikes with numerous innovations and a new innovation in urban mobility. 100% passion, perfection and the latest technology in every single product - Made in Germany, here in Raubling at the foot of the Bavarian Alps. Together we will inspire your customers.

BIKES DEVELOPED IN GERMANY, BAVARIA.

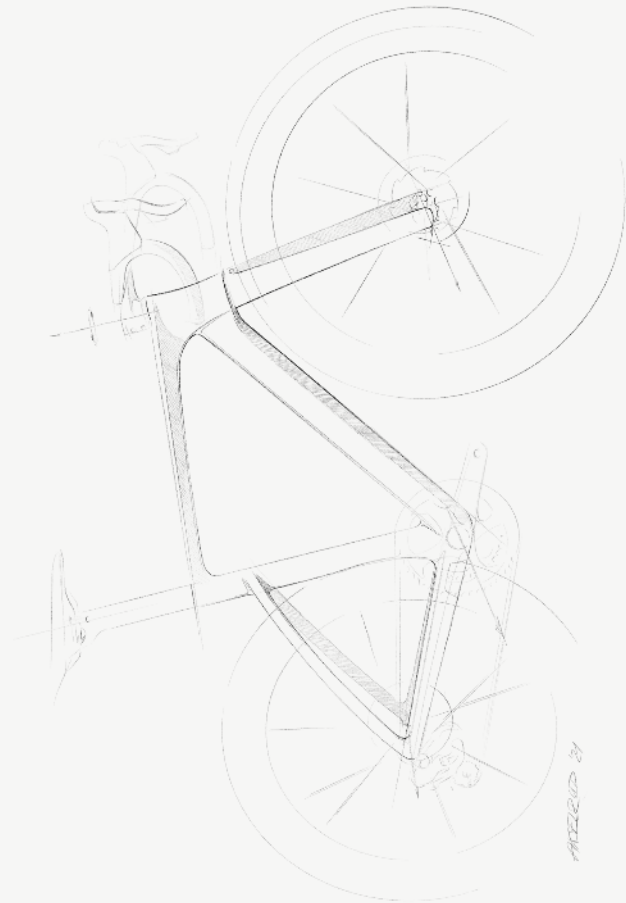

ENTWICKLUNG, DESIGN & PRODUKTION IN DEUTSCHLAND

Seit Bestehen der Marke corratec - und dies schon in der zweiten Generation - sind wir dem Standort Raubling in Deutschland treu geblieben. Entwicklung, Konstruktion, Design und Montage sind und bleiben an unserem Firmensitz in Bayern am Fuße der Alpen. In diesem Paradies leben wir unsere Werte wie Tradition, Innovation, Hochwertigkeit, Sportlichkeit und Leidenschaft. Alle Produkte werden vom Eigentümer und CEO Konrad Irlbacher persönlich auf den Straßen, Wegen und Trails getestet und anschließend zur Produktion freigegeben. Somit erhalten Sie die Sicherheit, dass jedes corratec Bike ein erstklassiges und einzigartiges Produkt ist. Unsere Fahrradschmiede in Raubling produziert revolutionäre Innovationen wie am laufenden Band. Auch für die Saison 2024 werden wir den Markt revolutionieren. Mit unserer brandneuen Rennmaschine im Rennradbereich, dem CCT EVO, setzen wir den Benchmark. Brandneu für 2024 sind die neuen Mountain Bikes und Gravel Bikes der EL Serie.

GERMAN DEVELOPMENT, DESIGN AND ENGINEERING

Since corratec was established, we have remained loyal to our location in Raubling, Germany, for more than two generations. Engineering, assembly, research and development (R&D) is located in our headquarters at the foot of the Bavarian Alps. In this paradise, we try to live by our values: tradition, innovation, quality, sportiness and passion. All products are personally tested by our owner and CEO Konrad Irlbacher on the streets, paths and trails in Upper Bavaria. After testing the products will be approved for production. This way we ensure that every corratec bike is a first-class and unique product. Our bicycle forge in Raubling produces revolutionary innovations as if they were on a conveyor belt. We will also revolutionise the market for 2024. With our brand new road bike, the CCT EVO, we are setting the benchmark in road racing. Brand new for 2024 are the new EL series mountain bike and gravel models.

WAS WIR ANSTREBEN

UNSERE MISSION

Mit corrateg startet die Zukunft heute. Mobilität und Transport werden immer wichtiger und stellen wichtige Lebensgrundlagen dar. Deshalb tragen wir als weltweit agierendes Unternehmen dazu bei, die damit verbundenen, hohen Ansprüche zu erfüllen und arbeiten so als Partner Ihrer Wahl an neuen unverzichtbaren wegweisenden technologischen Lösungen. Hierzu orientieren wir uns an den gesellschaftlichen Trends, sowie dem rasanten Wachstum der Weltbevölkerung und der damit zusammenhängenden Urbanisierung. Aus diesen Entwicklungen leiten sich für uns drei Megatrends ab, jene bilden die Basis für unser strategisches Handeln sowie all unserer Geschäftsaktivitäten:

WHAT WE ASPIRE TO BE

OUR MISSION

With corrateg, the future starts today. Mobility, transport and sustainability are becoming increasingly important. That is why we, as a globally active company, are contributing to meeting these high demands and working as your partner of choice on new, groundbreaking technology. We are guided by social trends and the rapid growth of the world's population and the urbanization that goes with it. Four megatrends are derived from these developments and form the basis for our strategic action and all our business activities:

INNOVATION



Seit 1990 begeistern wir unsere Kunden, erstaunen Wettbewerber und rufen Nachahmer hervor. Kaum ein anderes Produkt trägt so viele nützliche Erfindungen und Innovationen in sich wie ein corrateg Bike. Dies spürst du bei jeder Pedalumdrehung.

Since 1990, we have been inspiring our customers, astonishing competitors and evoking imitators. Hardly any other product carries as many useful inventions and innovations as a corrateg bike. Feel this with every turn of your pedals.

TRADITION

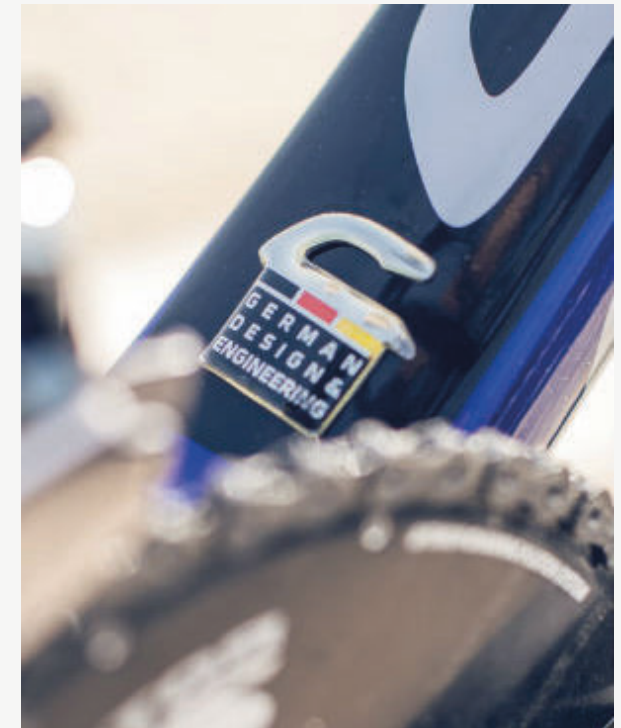

Seit Bestehen von corrateg – und dies schon in der zweiten Generation – sind wir dem Standort Raubling, Deutschland treu geblieben. Entwicklung, Konstruktion, Design und Montage (Produktion) sind und bleiben an unserem Firmensitz in Bayern am Fuße der Alpen.

Since corrateg was established, we have remained loyal to our roots in Raubling- Germany – and have continued to do so for the last two generations. Engineering, assembly, research and development are also located here in our headquarters at the foot of the Bavarian Alps.

QUALITÄT

QUALITY



Nur das Beste und das ist gerade gut genug! Das ist unser Anspruch für jedes einzelne Corratec Bike. Unsere Produktmanager und Entwicklungsingenieure setzen alles daran, um unsere Räder täglich zu verbessern. Hier kommen uns nur die hochwertigsten Komponenten und Materialien an unsere corratec Bikes.

Only the best and only the best is good enough! That is our aim for every single corratec bike. Our product managers and development engineers make every effort to improve our products every day. We only use the high-quality components and materials on our corratec bikes.

SPORTLICHKEIT

SPORTINESS



Seit Gründung 1990 ist der Rennsport fest in der DNA von corratec verankert. So konnten seither zahlreiche Erfolge auf regionaler, nationaler und internationaler Ebene gefeiert werden.

Since the foundation in 1990 racing is deeply embedded in the DNA of corratec. Therefore, the corratec athletes celebrated numerous victories in regional, national and international competitions since 1990.

WER WIR SIND, WAS WIR TUN

UNSERE VISION

Unser Hauptziel, welches wir seit 1990 verfolgen, ist das Rad den Menschen näher zu bringen. Jede Maßnahme, die uns diesem Ziel näherbringt, wird von unseren Unternehmenswerten bestärkt. Corratec ist innovativ, sportlich, traditionell und hochwertig. Wir lieben den Sport. Unsere Kunden und Mitarbeiter stehen stets im Mittelpunkt, deshalb legen wir besonderen Wert auf nachhaltiges Handeln. Gemeinsam möchten wir das Fahrrad neu erfinden und es zum Pendlerfahrzeug Nr. 1 im Nahverkehr machen.

WHO WE ARE, WHAT WE DO

OUR VISION

Our main vision, which we have been pursuing since 1990, is to bring cycling closer to more and more people. Every action that brings us closer to this goal is reinforced by our corporate values. corratec is innovative, sporty, traditional and high-quality. We love cycling, our customers and our employees are always in our focus which is why we place particular importance on acting sustainably. Together we want to re-invent the bicycle and make it the No. 1 commuter vehicle for local transport.

GESCHICHTE — HISTORY —

1972

Gründung IKO Sportfachhandel

Konrad Irlbacher Senior gründet ein Fachgeschäft für Sportartikel in Rosenheim.

Foundation

Konrad Irlbacher Senior establishes a shop for sporting goods in Rosenheim, Germany.

1983

Erster Radsportkatalog

Räder der Marke Sannino werden in das Sortiment aufgenommen.

First Bike Catalogue

The business starts selling Sannino bikes.

1990

corrateg entsteht

Räder werden nun selbst produziert und tragen den Namen corrateg.

corrateg is born

The business now focuses on manufacturing bikes under the brand name corrateg.

1993

BOW Design

corrategs einzigartiger Bogen mit Wiedererkennungswert gewinnt den Red Dot Design Preis.

BOW Design

corrategs unique BOW geometry is awarded with the Red Dot Design Prize.

1994

Erster Weltcup Sieg

Jan Ostergaard siegt beim MTB Weltcup. Ein Meilenstein in der corrateg Geschichte.

First MTB World cup title

Jan Ostergaard wins the MTB World Cup. The first milestone of the corrateg history.

1994

Erster WM Titel

Bruno Risi holt den ersten WM-Titel für corrateg auf der Bahn.

First World Champ title

Bruno Risi wins the first World Championship for corrateg on the race track.

1995

Scheibenbremsen fürs Rennrad

corrateg entwickelt das erste Rennrad mit Scheibenbremsen. Eine bahnbrechende Innovation des Gründers Konrad Irlbacher.

Disc Brake for Roadbikes

corrateg develops the first racing bike equipped with a disc brake.

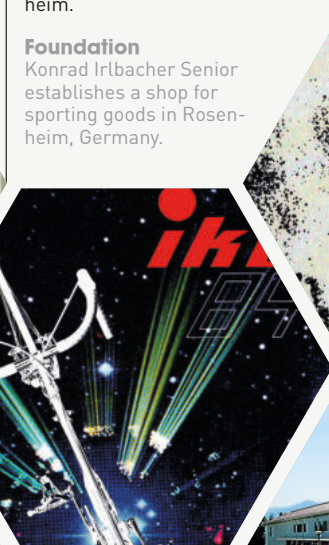

2000

Air Tech Technologie

Der Dämpfer ist erstmals mittig befestigt, was zu direkter Kraftübertragung ohne Energieverlust führt.

Air Tech Technology

The damper is fixed in the middle, which guarantees direct power control without any loss of energy.



HANDMADE BY MAURO SANNINO

Ich baue ihr Rad handgefertigt nach Maß. Absolute Maßgabe ihrer individuellen Wünsche, Ideen, Farben und ihrer persönlichen Präferenzen.

HIGH TECH

»

Ich baue ihr Rad handgefertigt nach Maß. Absolute Maßgabe ihrer individuellen Wünsche, Ideen, Farben und ihrer persönlichen Präferenzen.

2005

Handgefertigt

corrateg bietet seinen Kunden-Rahmen nach Maß an – handgefertigt unter der Leitung von Mauro Sannino.

Handmade

corrateg offers custom fitted frames – handmade by Mauro Sannino.

2006

Revolution

Neue Maßstäbe in Funktionalität und Design: Super leichtes und schnelles Race Hardtail aus Carbon mit TCM Technologie.

Revolution

A new standard in functionality and design: A super light and fast carbon race-hardtail with TCM technology.



2010

20 Jahre corrateg

Das Leitmotiv COLOR YOUR WAY! steht bei corrateg 2010 ganz besonders für einzigartige Fahrräder, lebendigen Fahrspaß und Fahrerlebnisse, die Alltag und Freizeit farbenfroh gestalten.

20 Jahre corrateg

The mission statement COLOUR YOUR WAY! stands in the corrateg 2010 series for unique bikes, active riding fun and experiences which colour up your day and your leisure time.

2013

Inside Link

Eine weitere Innovation entsteht. Allein durch die Kinematik bleibt der Hinterbau im Antritt straff ohne separaten Lockout.

Inside Link

Another innovation from iko corrateg. Due to the unique kinematic, the rear triangle remains tight during acceleration without remote lockout.



2013

Markteinführung E-Bikes

Markteinführung der ersten E-Bikes von corrateg.

Market introduction e-Bikes

Introduction of the first corrateg e-bikes.



2014

Deutscher Skiverband

corrateg ist offizieller Lieferant der Deutschen Ski Nationalmannschaften.

German Ski federation

corrateg is official supplier of the German National Skiing Teams.



2015

25 Jähriges Firmenjubiläum

corrateg blickt auf ein Viertel Jahrhundert Firmengeschichte zurück.

25 years company anniversary

corrateg looks back on a quarter century of company history.

2017

Fusion Tube Edge

Der erste weltweit stabilste und sicherste corratec E-Bike Rahmen wird entwickelt.

Fusion Tube Edge

The world's first most stable and safest corratec E-Bike frame.

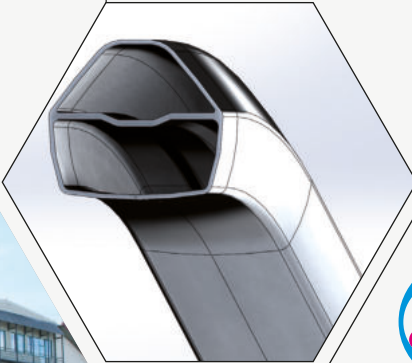

2019

Design Innovation Award

corratec wird für das innovative Life S Konzept ausgezeichnet.

Design Innovation Award

corratec is awarded for the innovative Life S concept.



2018

German Brand Award

corratec wird erstmalig mit dem German Brand Award als eine der beliebtesten Marken prämiert.

German Brand Award

For the first time corratec is honored with the German Brand Award as one of the most popular brands.

2020

German Brand Award

corratec erhält erneut die begehrte Auszeichnung als innovativste Marke in ihrem Segment.

German Brand Award

corratec once again received the prestigious award as the most innovative brand in its segment.



2021

German Design Award

Das neu entwickelte Carbon Konzept E Power iLink 180 begeistert die Jury und prämiiert die Marke mit dem Design Award.

German Design Award

The newly developed Carbon Concept E Power iLink 180 impressed the jury and presented corratec with the Design Award.

2021

Shadow Edge 3.0

Die neue Rahmenkonstruktion von corratec erzeugt eine maximale Verwindungssteifigkeit des Unterrohrs.

Shadow Edge 3.0

The new frame design from corratec creates maximum torsional rigidity of the down tube.



2022

German Innovation Award

Die Mobilität der Zukunft, das corratec Life S Dual, gewinnt auf Anhieb den German Innovation Award.

German Innovation Award

The mobility of the future, our corratec Life S Dual, wins the German Innovation Award.



2022

ABC Award

Awards am laufenden Band für die Mobilität von Morgen. Das corratec Life S Dual gewinnt auch den ABC Award.

ABC Award

The next award for the mobility of tomorrow. The corratec Life S Dual also wins the ABC Award.



**GERMAN
DESIGN
AWARD
SPECIAL
2023**

2023

German Design Special Award

Für sein einzigartiges Design wurde der Life S Dual 2023 bereits mit dem German Design Award Special ausgezeichnet.



**german
brand
award
23
winner**

2023

German Brand Award

corrateg erhält erneut die begehrte Auszeichnung als innovativste Marke in ihrem Segment.

German Brand Award

corrateg once again received the prestigious award as the most innovative brand in its segment.

German Design Award Special
The Life S Dual 2023 has already received the German Design Award Special for its unique design.

2022 BIKES MADE IN EUROPE, ROMANIA.

ERWEITERUNG UNSERER PRODUKTION IN TIMISOARA

Ende 2021 konnten wir ein neues Betriebsgelände mit einer Größe von ca. 50.000m² inklusiv bebauter Fläche mit ca. 30.000m² an dem bestgelegenen Standort in Timisoara, Rumänien, erwerben. Damit reißen wir uns als Premium- Unternehmen neben bereits ansässigen Weltunternehmen wie Hilti, Bosch, Continental, Hela, Philips ein. Wir verfügen an diesem neuen Standort über qualifizierte Fachkräfte, um die Hochwertigkeit der corrateg Produkte auch in Zukunft zu sichern und weiter auszubauen.

Dieser neue Standort ermöglicht uns, die stark steigende Nachfrage der kommenden Jahre zu bewältigen. Verifiziert man die Parameter, Strecke, Zeit und Ressourcen, so befindet sich dieser Standort in einer geographisch optimalen Lage, im Herzen Europas. Alleine die Verkürzung der Lieferwege, ermöglicht uns eine Einsparung von ca. 700 Tonnen CO₂ pro Jahr. Verbaute Solarpanel für die Stromerzeugung werden zusätzlich ökologische Effekte erzielen, um ein corrateg Fahrrad oder E-Bike auch umweltschonend zu produzieren. Seit Januar 2022 werden in Timisoara corrateg Räder gefertigt.

EXPANSION OF OUR PRODUCTION IN TIMISOARA

At the end of 2021, we were able to acquire a new company site with a size of approx. 50,000m² including a developed area of approx. 30,000m² at the best-located site in Timisoara in Romania. With this acquisition, we join the ranks of premium companies such as Hilti, Bosch, Continental, Hela, Philips and many others. At this new location, we have highly qualified specialists at our disposal to ensure and expand the high quality of corrateg products further in the future.

This new location will allow us to cope with the strong increase in demand over the coming years. Checking the parameters: distance, time and resources, this location is in a geographically optimal position, located in the centre of Europe. The shortening of the delivery routes alone enables us to save approximately 700 tonnes of CO₂. Built-in solar panels for power generation will achieve additional ecological benefits to produce a corrateg bike or e-bike in an environmentally friendly manner. Since January 2022, some corrateg bikes are manufactured in Timisoara.

AWARDS

SEIT JAHREN VORNE DABEI

IN THE LEAD FOR YEARS

EINE ERFOLGSGESCHICHTE, DIE ANHÄLT
A SUCCESS STORY THAT LASTS



**GERMAN
DESIGN
AWARD
SPECIAL
2021**

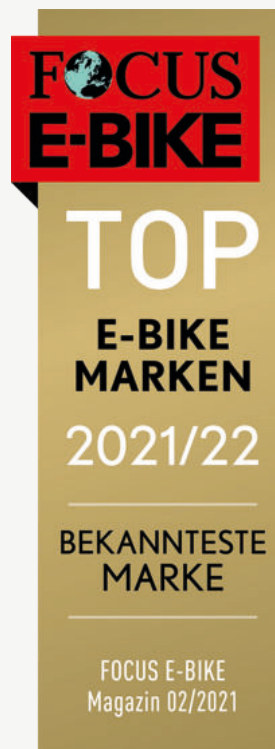

**GERMAN
DESIGN
AWARD
WINNER
2022**



**GERMAN
INNO
VATION
AWARD '22
WINNER**



PASSION OF CYCLING
NACHWUCHS-STARS
UPCOMING STARS

TEAM CORRATEC GIRO D'ITALIA 2023



Der Giro d'Italia ist Geschichte, mitgeschrieben hat sie auch corratec, denn die Raublinger stellten das aktivste Team und zeigten sich mit den meisten TV-Minuten aller Mannschaften 2023. Über 10 Ausreißergruppen, das hätte vor der Corsa Rosa keiner von der jüngsten Mannschaft erwartet. Das Team vom deutschen Radhersteller aus Raubling zeigte sich nicht nur mutig, sie zeigten sich auch tagtäglich auf's Neue mit Attacken in den Ausreißergruppen. Dabei konnten sowohl in der Wertung um das Sprint-, wie auch Bergtrikot wertvolle Punkte gesammelt werden.

„Die Moral unserer jungen Fahrer ist großartig. Hier wird tagtäglich auf's Neue gekämpft, ohne an das Leiden und die Schmerzen des Folgetages zu denken. Ganz getreu unserem corratec Motto - We are young, wild and free. Genau die Haltung, welche wir und auch Konrad Irlbacher als CEO von unserer Mannschaft sehen wollten“, so Steffen Thum, der das Team corratec über die drei Wochen in Italien begleitete. Mut wird belohnt und der Lohn folgte noch während der Rundfahrt in Italien. Nicht in Form eines Tagessieges, sondern mit einer direkten Einladung zur Deutschlandtour 2023.



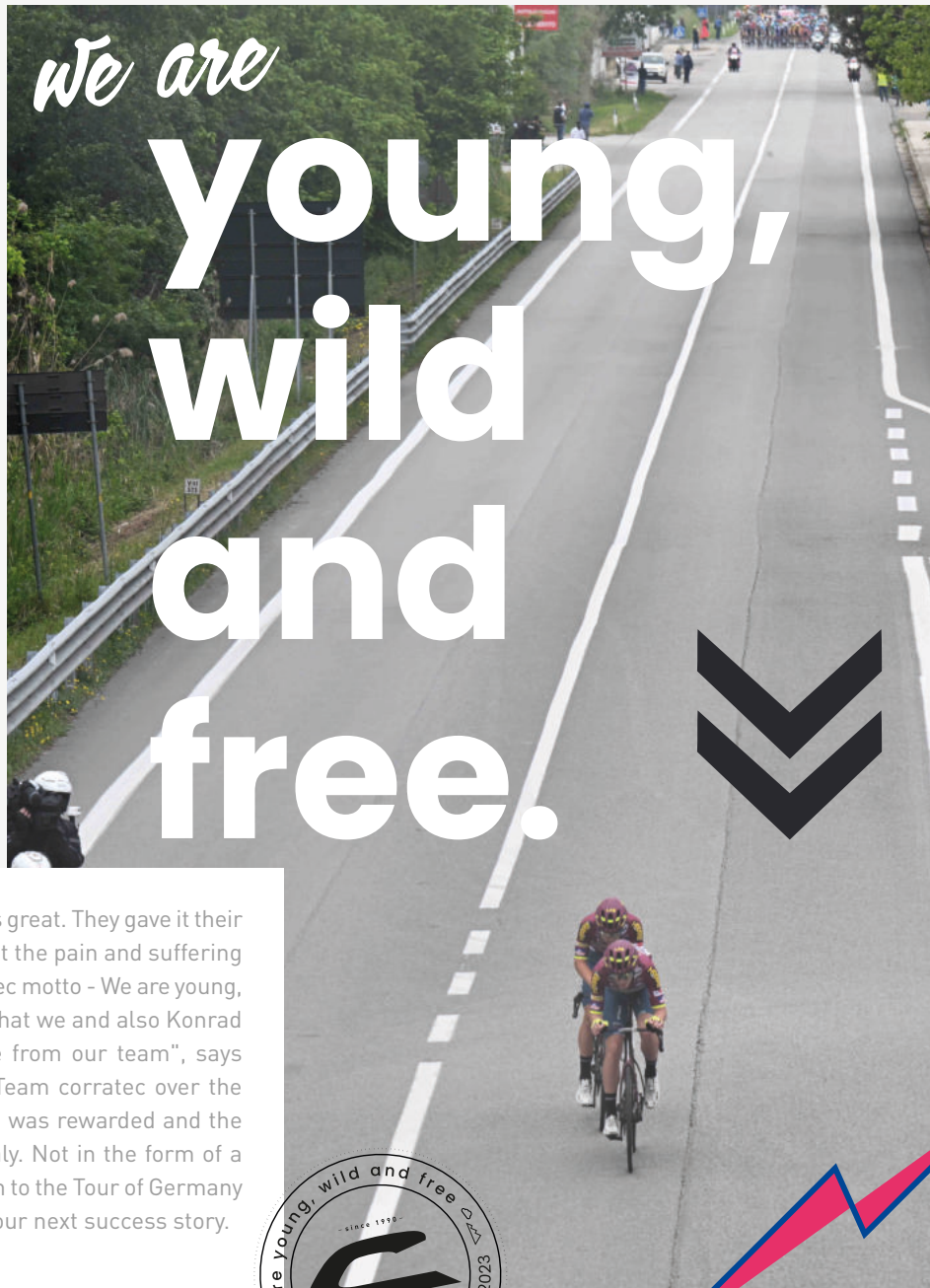

The Giro d'Italia is over, and corratec was a big part of it, as the team from Raubling was the most active team and had the most TV coverage of all teams in 2023. Active in more than 10 breakaway groups, nobody would have expected this from the youngest team before the Giro. Team corratec: the riders from the German bike manufacturer in Raubling, were not only daring, they also attacked day after day and were part of the breakaway groups. They collected valuable points in the classifications for the sprint jersey as well as the mountain jersey.

"The morale of our young riders was great. They gave it their all every day, without thinking about the pain and suffering the following day. True to our corratec motto - We are young, wild and free. Exactly the attitude that we and also Konrad Irlbacher, our CEO, wanted to see from our team", says Steffen Thum, who accompanied Team corratec over the three weeks in Italy. Their courage was rewarded and the reward came during the Giro in Italy. Not in the form of a stage win, but with a direct invitation to the Tour of Germany 2023. And now we look forward to our next success story.



THE TEAM BIKE
FAST AND WILD
FAST AND WILD

CCT EVO TEAM & CCT EVO WILD EDITION

Das Geheimnis der Geschwindigkeit gelüftet! Man muss nicht mehr zwischen Gewicht, Aerodynamik, Fahrqualität und Geschwindigkeit wählen. Der Rahmen wiegt nur 800 g ohne Abstriche bei der Aerodynamik, Steifigkeit oder Fahrqualität. In unserem Bestreben, für jeden das perfekte Rad zu finden, haben wir hier maximale Anpassungsfähigkeit mit einem Minimalismus und einer Schönheit von Form und Linien umgesetzt. Kein Gramm zu viel, kein Feature überflüssig. Getreu dem Motto "So viel wie nötig, so wenig wie möglich". Die Zeiten, in denen wir einen Kompromiss zwischen Gewicht und Aerodynamik eingehen mussten, sind vorbei.

In Verbindung mit dem Oberrohr fließt das Design perfekt in die Gabel ein und bildet die Form eines Bumerangs. Integration in Perfektion. Ein optisches Highlight kombiniert mit hervorragenden Fahreigenschaften: Laufruhe, Stabilität & Agilität. Gleichzeitig können Reifen bis zu 32mm montiert werden.



SECRET OF SPEED

The secret of speed uncovered - you don't have to choose between weight, aerodynamics, ride quality or speed anymore. 800g frame weight without sacrificing aerodynamics, stiffness or ride quality. In our quest to provide the perfect bike for everyone, we've implemented maximum customisability here with minimalism and beauty of shape and lines. Not a gram too much, no feature useless. True to the motto "As much as necessary, as little as possible". The times where we had to compromise between weight and aerodynamics are now over.

In conjunction with the top tube, the design flows perfectly into the fork, forming the shape of a boomerang. Perfect integration. A visual highlight combined with outstanding handling characteristics: smooth running, stability & agility. At the same time, tyres up to 32mm can be mounted.



800 GR

Rahmengewicht
ohne Lackierung
FRAME WEIGHT
WITHOUT PAINT

AXS 12S

Kabelloses Schalten
RACE COCKPIT
WIRELESS SHIFTING

30 WATT

Ersparnis durch verbesserte Aerodynamik

SAVINGS FROM
AERODYNAMICS

**REACH-
STACK**

Sportliches &
aggressives Fahrrad

SPORTY &
AGGRESSIVE BIKE

CCT EVO TEAM



- since 1990 -

AERO UPHILL RACEMACHINE

CCT EVO WILD EDITION



MOUNTAINBIKE RACINGTEAM

Wenn die größten Konkurrenten plötzlich für einen gemeinsamen Erfolg eintreten. Mit unserem Mountainbike Racingteam zeigen wir, dass Weltcup Sieger aus verschiedenen Nationen, Kulturen, Kontinenten und Disziplinen voneinander lernen, profitieren und für einen gemeinsamen Erfolg kämpfen können.

When the greatest competitors suddenly unite for a common goal. With our Mountainbike Racingteam, we show that World Cup winners from different countries, cultures, continents and disciplines can learn from each other, benefit from each other and compete for joint success.



Simon Gegenheimer



Titouan Perrin Ganier



#goinginternational

BEL - BRA - CH - FRA - GER - MEX - PUR



REVO BOW WM EDITION

Die REVO BOW Bikerange ist bekannt für ihr innovatives Design. Perlmuttlackierung, stylisch gewölbtes Oberrohr und cleanes Kabelrouting mit innen verlegten Zügen. Im Renngeschehen auf Weltklasse Niveau sticht das Bike auffallend hervor und hebt sich von den anderen Rennmaschinen ab. Individualität ist hier die Prämisse!

The Revo Bow bike range is known for its innovative design. A pearlescent finish, stylishly curved top tube and clean cable routing. In world-class racing, the bike clearly attracts attention and differentiates itself from the other racing machines. The motto here is to be unique!



SPONSORING AMERICA WIR MACHEN SIEGER SEIT 2018 WE MAKE CHAMPIONS SINCE 2018

CORRATEC USA / AMERICA

Seit August 2018 ist corrateg mit einer eigenen Niederlassung am amerikanischen Markt vertreten. Alle Vorgänge werden von unserem Headquarter in FT. Lauderdale, Florida gesteuert. Nicht nur in den USA, sondern auch in der dominikanischen Republik, Panama, Ecuador und Puerto Rico ist die Marke corrateg stark präsent und wächst stetig.

corrateg has had its own subsidiary on the American market since August 2018. All processes are carried out and controlled from our headquarters in FT. Lauderdale, Florida. The corrateg brand has a strong presence and is growing steadily not only in the USA, but also in the Dominican Republic, Panama, Ecuador, Puerto Rico and many more.



FERNANDO BOLONA

corrateg Repräsentant in Amerika

Head of America Operations



CORRATEC AMERICA 2ND BIKE ELITE TEAM

Die intensive Partnerschaft zwischen corrateg und unserem Partner „2nd Bike“ besteht seit mehreren Jahren und kann bereits großartige Erfolge vorweisen. Teamfahrer Ricky Morales wurde nun sogar als Fahrer für das UCI MTB Racingteam bestätigt.

The intensive partnership between corrateg and our partner “2nd Bike Elite” has existed for several years and can already boast some great successes. Team rider Ricky Morales has now even been nominated for the UCI MTB Racingteam.

FLORIDA HBGS CORRATEC TEAM

Das in Hialeah im Bundesstaat Florida ansässige Rennteam setzt seit Jahren auf die Marke corrateg. Mit ihren Spitzenfahrern nimmt das Team in ganz USA an verschiedenen Rennen teil. Der Firmensitz unseres Partner-Unternehmens in Miami, Florida ist Anlaufpunkt für viele corrateg Teams und Logistikzentrum zugleich. Von dort werden alle Vorgänge koordiniert.

The racing team based in Hialeah, Florida, has relied on the corrateg brand for years. With their top riders, the team takes part in various races all over the USA. The headquarters of our partner company in Miami, Florida is the contact point for many corrateg teams and a logistic base as well. All processes are coordinated from there.



TEAM PUERTO RICO

Seit 2021 führt das Team corrateg Puerto Rico die erfolgreiche Tradition und großartige corrateg Erfolgsgeschichte im Spirit von corrateg – passion of cycling – erfolgreich weiter.

Since 2021, the team corrateg Puerto Rico started to represent the corrateg tradition far away from corrateg's home, of course keeping the same values.

PANAMA RPC CORRATEC TEAM

Das aus Panama stammende RPC Racing Team besteht mittlerweile aus einer Vielzahl an Leistungsträgern – weiblich wie männlich. Herausragende Erfolge konnten bereits auf unseren corrateg Rennrädern eingefahren werden.

The RPC Racing Team from Panama consists of a large number of top performers – female and male. Outstanding successes have already been achieved on our corrateg road bikes.



VICTORIES WIR SCHAFFEN ERINNERUNGEN WE CREATE MEMORIES THAT LAST

- 20 × bei großen int. Radmarathons
at huge international cycling marathons
Nove Colli | Felice Gimondi, Amade | Engadin | Dolomiten | Mondsee & more
- 20 × bei großen int. Bergrennen
at huge international mountain races
Kaunertaler | Kühtai | Kitzbüheler Horn | Stilfserjoch | Penserjoch & more
- 12 × Gewinner Grossglockner Herren und Damen
Winner Grossglockner Men and Women
- 8 × Mastereuropameister - Zeitfahren & Straße
Master European Champion - Timetrial & Road
- 7 × Sieg "Dolomitenman" Herren
Victory "Dolomitenman" Men
- 5 × Gesamtsieg Glocknerkönig Strecke "Classic"
Overall Victory Glocknerkönig Track "Classic"
- 4 × Gesamtsieg Öztaler Radmarathon
Overall Victory Öztaler Radmarathon
- 3 × Etappensiege Giro d'Italia
Stage victories Giro d'Italia
- 3 × Etappensiege Transalp MTB
Stage victories Transalp MTB





corrateg

WORLD TEAMS & ATHLETES

BESONDERE AUSGEWÄHLTE

LEISTUNGSTRÄGER

SELECTED SPECIAL RIDERS

Jan Erik Ostergaard | DK

Bruno Risi | CH

Kurt Betschart | CH

José Rujano | VE

Iván Parra | VE

Franz Stocher | AT

Dirk Müller | DE

Roland Stauder | IT

Michael Casagrande | IT

Michael Spögler | IT

Johannes Berndt | DE

Bernd Hornetz | DE

Wolfgang Hoffmann | DE

Daniel Debertin | DE

Frederic Glorieux | BE

Bob Michels | BE

Andreas Schmoll | DE

Isabell Vogel | DE

Ben Witt | DE

Stefan Oetli | DE

Jan Wessely | DE

Michael Markolf | DE

Simon Gegenheimer | GER

Marion Fromberger | GER

Steffen Thum | GER

Remi Laffont | FRA

Gali Weinberg | ISR

Rob Vanden Haesevelde | BEL

Team Vini Zabú | ITA

Markus Emmerich | DE

Martin Reisner | DE

Tomas Mojares | PHIL

Bart Bury | BEL

Klaus Steinkeller | DE

Michael Kastinger | DE

Lisa Neumüller | DE

Andreas Ortner | DE

Felix Spensberger | DE

Jany Messmann | DE

Kuno Messmann | DE

Reinhilde Mager | DE

Karin Bordhin | DE

Roland Döring | DE

Jocelyn Verdenal | FRA

Matthijs Koedik | NED

**VICTORIES
WIR SCHAFFEN ERINNERUNGEN
WE CREATE MEMORIES THAT LAST**





Weltcup Gesamtsieger UCI MTB Eliminator
Overall World cup UCI MTB Eliminator

Grünes Trickot Giro d'Sicilia
Green Jersey Giro d'Sicilia

Weltmeister UCI MTB Eliminator
World champion UCI MTB Eliminator

Weltmeister im Punktefahren
World Champion Track Point Race

Grünes Trikot Giro d'Italia
Green Jersey Giro d'Italia

Sechstagesport Sieger
Six days Sport victories

Gesamtweltcupssieger MTB Marathon Damen und Herren
World Cup Winner MTB Marathon Men and Women

Europameistertitel Team Relay Moskau
European Championship Team Relay Moscow

Weltcup Gesamtsieg im Punktefahren
World Cup overall Track Point Race

Crocodil Trophy Australia
Crocodil Trophy Australia

MTB UCI Worldcup Sieg Valkenswaard I Niederlande
Victory MTB UCI Worldcup Valkenswaard I Netherlands

Bergwertung Deutschland Tour
King of the mountain Tour of Germany

MTB UCI Worldcup Sieg Barcelona I Spanien
Victory MTB UCI Worldcup Barcelona I Spain

Etappe UCI Pro Tour Trofej Umag I Kroatien
Stage Victory UCI Pro Tour Trofej Umag I Croatia

Etappe UCI Pro Tour Coppi e Bartali I Italien
Stage Victory UCI Pro Tour Coppi e Bartali I Italy



DAS NEUE
THE ALL NEW

CCT EVO

WIR SETZEN NEUE MASSSTÄBE
WE ARE SETTING NEW STANDARDS

Wie auch bei dem Vorgänger sind wir wieder den Weg des geringsten Widerstands gegangen. Schließlich soll man sich bei uns nicht zwischen Gewicht, Aerodynamik, Fahrqualität oder Geschwindigkeit entscheiden müssen. Und was sollen wir sagen: 800g Rahmengewicht ohne Abstriche bei der Aerodynamik, Steifigkeit oder Fahrqualität. In unserem Bestreben für jeden das perfekte Bike zu bieten, haben wir hier maximale Individualisierbarkeit umgesetzt mit einem zugleich unübertroffenen Perfektionismus. Kein Gramm zu viel, kein Feature unnütz - ganz nach dem Motto "So viel wie nötig, so wenig wie möglich". Die Zeiten in denen wir einen Kompromiss zwischen Gewicht und Aerodynamik eingehen mussten, sind nun vorbei, mit dem schnellsten corraterc Rennrad, aller Zeiten.

As with the predecessor, we took the path of least resistance here. Finally, you shouldn't have to choose between weight, aerodynamics, ride quality or speed. And what can we say: the frame only weighs 800g without sacrificing aerodynamics, stiffness or ride quality. In our quest to provide the perfect bike for everyone, we've implemented maximum customisability here with an unsurpassed minimalism at the same time. Not a gram too much, no feature useless. True to the motto "As much as necessary, as little as possible". The times where you had to compromise between weight and aerodynamics are now over with the fastest corraterc road bike ever.



CCT EVO

FAST JUST GOT FASTER

FEDERLEICHT

FEATHERLIGHT

Unglaublich, aber wahr. Der neue Rahmen kommt auf ein sensationelles Gewicht von 800 Gramm und ist zugleich noch supersteif. Eine absolute Allzweckwaffe, Climber, Sprinter und Rouleur in einem Paket.

Unbelievable but true. The new frame only weighs 800 grams: sensationally light and super stiff at the same time. An absolute all-purpose road bike, climber, sprinter and time triallist in one package.

SPORTLICH & AGGRESSIV

SPORTY & AGGRESSIVE

Das neue CCT EVO ist sportlicher und aggressiver unterwegs als sein Vorgänger. Dafür wurde der Faktor bzw. das Verhältnis zwischen Reach & Stack neu definiert. Der Reach ist länger und der Stack Tiefer. Mit dieser sportlichen und gleichzeitig komfortablen Sitzposition gewinnst du zusätzliche 8 Watt.

The new CCT EVO is sportier and more aggressive than its predecessor. To achieve this, the factor or the relationship between the reach and stack has been redefined. The reach is longer and the stack lower. With this sport-y seating position, which is also comfortable, you gain an additional 8 watts.





BOW SITZSTREBE *BOW SEAT STAY*

Der legendäre corratec Bow darf auch beim neuen CCT EVO nicht fehlen. Die neue Sitzstreben wurden in der traditionellen Rahmenform entwickelt und bietet technische Innovationen auf Weltklasse Niveau. Nur ein Stichwort: 8 Watt. Der Leistungsvorteil den Dir die Bow Sitzstreben bieten. Gleichzeitig werden Micro Vibrationen abgedämpft ohne dabei an Steifigkeit zu verlieren.

The legendary corratec Bow is also a must for the new CCT EVO. The new seat stays were developed in the traditional frame shape and offer technical innovations on a world-class level. Just one keyword: 8 watts is the power advantage that the Bow seat stays offer you. At the same time, micro vibrations are dampened without losing stiffness.

INTEGRATION IN PERFEKTION *PERFECT INTEGRATION*

Perfektion ist der neue Standard beim CCT EVO. Es wurde alles integriert was nur integriert werden kann. Sogar die Ausfallenden der Steckachsen sind komplett im Rahmen integriert und bilden einen formschönen sowie aerodynamischen Abschluss. Der entsprechende Sechskant Schlüssel zum Entfernen der Achse ist immer am Fahrrad, um das Hinter- bzw. Vorderrad jederzeit entfernen zu können.

Perfection is the new standard for the CCT EVO. Everything that can be integrated has been integrated. Even the dropouts of the thru axles are completely integrated into the frame and form an attractive and aerodynamic finish. The corresponding hexagonal key for removing the axle is always on the bike and the rear or front wheel can be removed at any time.



RACE COCKPIT

Rennfahren wie die Profis. Dank ergonomischer Lenkerdrops, die speziell an die Taillierung der Daumen angepasst wurden, kannst du eine perfekte aerodynamische Position einnehmen und fühlst dich dabei noch pudelwohl. Eine Computer Mount ist integriert und fügt sich formschön in die Optik des Cockpits ein.



Race like the pros. Thanks to ergonomic handlebar drops that have been specially adapted to the crook of the thumbs, you can adopt a perfect aerodynamic position and still feel very comfortable. A computer mount is integrated and fits beautifully into the look of the cockpit.

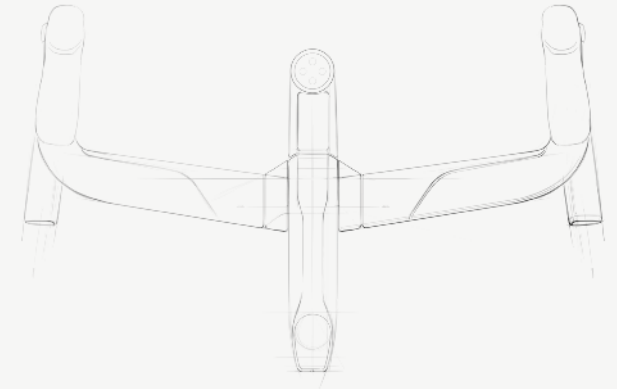

BUMERANG LINE

Mit der Designsprache erinnert die neue Gabel an einen Bumerang, daher auch der Name "Bumerang Line". In Verbindung mit dem Oberrohr läuft das Design perfekt in die Gabelform über. Integration in Perfektion. Optisch ein Highlight, kombiniert mit herausragenden Fahreigenschaften: Laufruhe, Stabilität & Agilität. Gleichzeitig können Reifen bis zu 32mm montiert werden.

With its design, the new fork is reminiscent of a boomerang, hence the name «Boomerang Line». In conjunction with the top tube, the design flows perfectly into the fork shape. Perfect integration. A visual highlight combined with outstanding handling characteristics: smooth running, stability & agility. At the same time, tyres up to 32mm can be mounted.



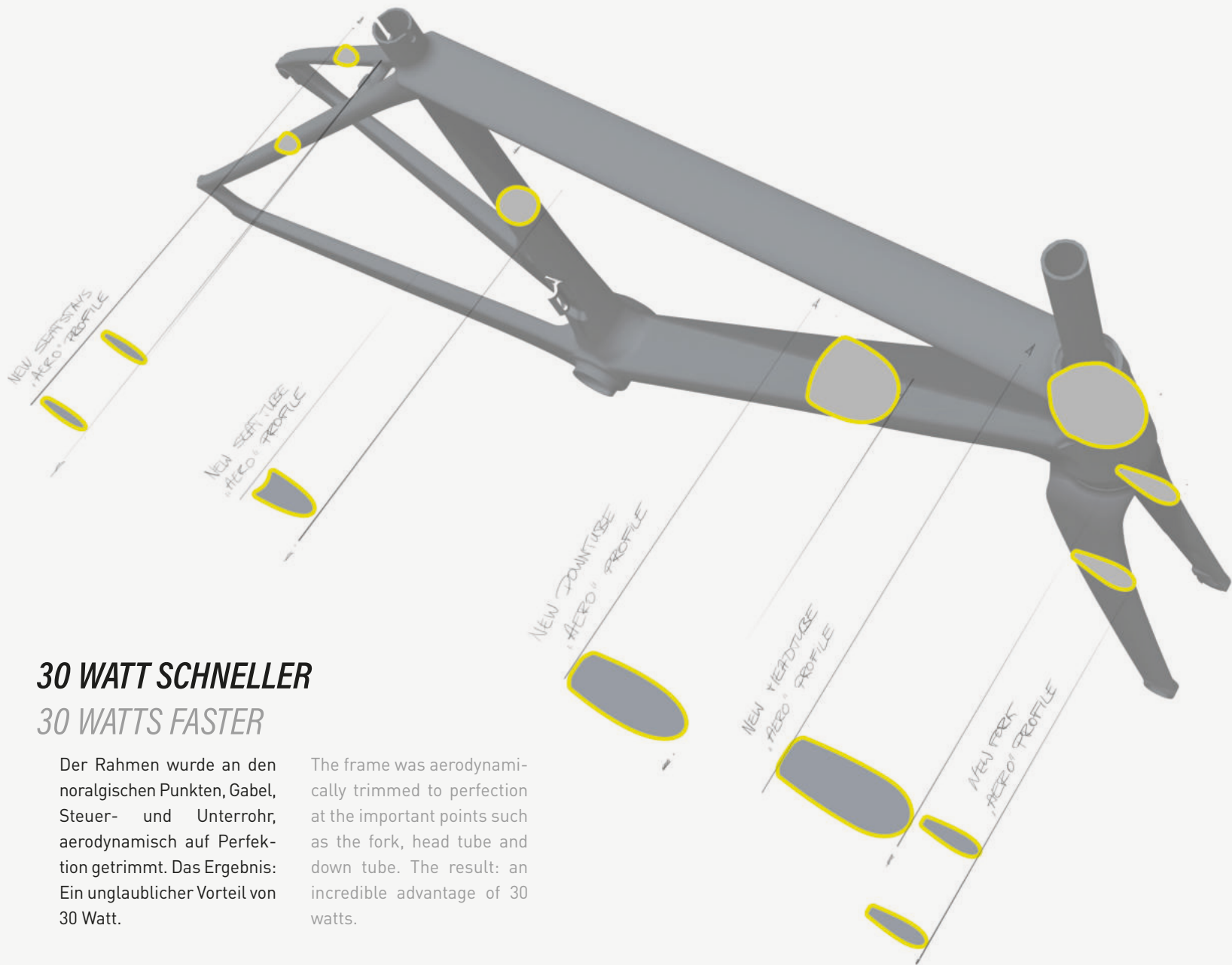

30 WATT SCHNELLER

30 WATTS FASTER

Der Rahmen wurde an den aerodynamischen Punkten, Gabel, Steuer- und Unterrohr, aerodynamisch auf Perfektion getrimmt. Das Ergebnis: Ein unglaublicher Vorteil von 30 Watt.

The frame was aerodynamically trimmed to perfection at the important points such as the fork, head tube and down tube. The result: an incredible advantage of 30 watts.

UNSERE DEFINITION VON PERFEKTION OUR DEFINITION OF PERFECTION

SHADOW EDGE TUBE 3.0

BIONIC DESIGN

Technologie der Zukunft vereint in extravaganter Design – die neue bionische Rahmenkonstruktion von corrateg erzeugt eine maximale Verwindungssteifigkeit des Unterrohrs und garantiert somit höchstmögliche Sicherheit für den Fahrer. Der Bosch PowerTube 750Wh Akku verschwindet zu 100% im Rahmen und integriert sich form-schön in die exklusive Linienführung des Bionic Designs. Die neue Designgebung von corrateg bietet somit weitreichende Vorteile beim Handling und Funktionalität in Verbindung mit dem Bosch Smart System.

Future innovations combined with an extravagant design – the new corrateg bionic frame construction provides maximum torsional rigidity of the down tube. The innovative frame ensures the best possible safety and functionality for our riders. The Bosch PowerTube 750 Wh battery disappears 100% into the frame and is elegantly integrated into the unique shape of the Bionic design. The new corrateg Bionic Design offers a various number of advantages in handling combined with the new Bosch Smart System.



INNOVATIONEN
— INNOVATIONS —

**"Weltweit stabilster und
sicherster corrated E-Bike
Rahmen -
DIE NÄCHSTE GENERATION"**

*"world's most stable and safest
corrated e-bike frame -
THE NEXT GENERATION"*

SHADOW 3.0 EDGE TUBE FEATURES

BIONIC GRIP

Die bioinsche Struktur des Akkucovers bietet dem Fahrer beim Herausnehmen des Akkus besten Grip und verhindert somit ein Entgleiten aus der Hand. Das Handling wurde dadurch deutlich erleichtert. Der völlig im Rahmen integrierte Deckel überzeugt mit einer fließenden Linienführung und sorgt für eine cleane Optik.

The bioinic structure of the battery cover provides superior grip when removing the battery and prevents it slipping out of your hand. This cover makes it much easier to handle. The cover, which is fully integrated into the frame, impresses with its flowing lines and ensures a clean look.

BIONIC COOLING

Die speziell für das neue Shadow Edge 3.0 designten Lüftungsschlitze versorgen den Bosch Motor mit ausreichend Frischluft und vermeiden eine Überhitzung bei starker Belastung. Eine maximale Leistung des Motors auch bei steilen Anstiegen ist somit immer gewährleistet.

The ventilation slots are specially designed for the new Shadow Edge 3.0 and provides the powerful Bosch drive unit with sufficient fresh air and prevents overheating. This ensures that the drive unit delivers maximum power at any time.



BIONIC SAFETY LOCK

Der speziell für das Shadow Edge Tube 3.0 entwickelte Verschlussmechanismus reduziert durch seine smarte Aufnahme den Ausschnitt des Unterrohrs und erhöht dadurch die Verwindungssteifigkeit des Rahmens um ein Vielfaches. Die doppelte Sicherung arretiert den Akku bombenfest im Schacht und verhindert somit ein Klappern oder selbstständiges Lösen während der Fahrt.

The locking mechanism, specially developed for the Shadow Edge Tube 3.0, reduces the cutout of the down tube thanks to its smart mounting and increases the torsional stiffness of the frame. The double safety mechanism locks the battery firmly in the slot and prevents it from rattling or loosening while riding.

STABILITY BIONIC & SAFETY

Eine zusätzliche Verstrebung, die in den Rahmen eingearbeitet wurde, erhöht die torsionale Steifigkeit des Unterrohrs um ein Vielfaches. Der Fahrer erhält dadurch maximale Kontrolle im schwierigen Gelände.

To increase the torsional rigidity of the down tube an additional bar has been integrated inside the frame. This feature ensures maximum control for the rider in difficult terrain.

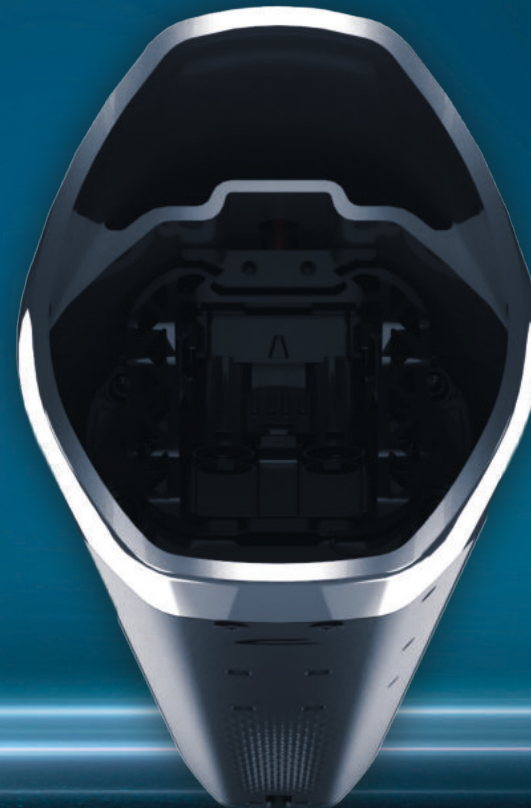

BETTER TOGETHER ...



HUBERBUAM BERCHTESGADEN

Die Brüder Thomas und Alexander Huber, ein weltweit bekanntes Extrembergsteiger Duo, setzen auf Elektro. Beide haben ihre E-Mountainbikes von corratec erhalten, mit denen sie besonders schnell zum Einstieg ihrer nächsten Klettertour kommen.

The brothers Alexander and Thomas Huber, both extreme mountaineers, rely on electric power. Both ride corratec E-Bikes, to help them reach the start of their climbing adventures quickly and comfortably.

KLITSCHKO BROTHERS

Die Brüder Wladimir und Vitali Klitschko begeistern sich beide in ihrer Freizeit für's Radfahren. Hierfür haben Sie sich persönlich von dem Rahmenbaumeister Mauro Sannino vermessen lassen, um später ihr maßgefertigtes Rad abzuholen.

The brothers Wladimir and Vitali Klitschko are both avid cyclists in their free time. Putting extreme demands on a bike for their height and weight, both chose to be measured and have a custom bike built by Mauro Sannino.



CORRATEC PARTNER

— AMBASSADORS —

DSV PREMIUM PARTNER

Die strategische Partnerschaft mit dem deutschen Skiverband verbindet unsere Premium Marke mit dem Spitzensport. Viele Profi Wintersport Athleten trainieren auf unseren corrateg Bikes zur Vorbereitung für ihre Wettkämpfe.

The strategic partnership with the German ski association connects our premium brand with top-class sport. Many professional winter sports athletes ride our bikes to train and prepare for their races.



ADELHOLZENER PREMIUM PARTNER

Die Heimat der Adelholzener Alpenquellen sind die bayerischen Alpen. Hier stellt das Unternehmen Heilwasser, Mineralwasser und Erfrischungsgetränke her. Seit 2014 ist Adelholzener offizieller Kooperationspartner corrategs.

The home of Adelholzener Alpenquellen is in the Bavarian Alps. The company produces mineral water, healing water, and soft drinks under the brand Adelholzener and Active 02. Adelholzener has been an official partner of corrateg since 2014.



WAS IST DEINE MISSION? WHAT'S YOUR MISSION?



URBAN

Mit Deinem corratec urban Bike erreichst Du Deinen Arbeitsplatz oder das Café-Date absolut stressfrei und immer pünktlich! Mit Deinem Umweltbewusstsein leistest Du einen großen Beitrag zum Wandel in der urbanen Mobilität der Zukunft.

With your corratec urban bike you can reach your workplace or your coffee date stress-free and always be on time! With your environmental awareness you're making a major contribution to the change in urban mobility of the future.



TOUR

Traumhafte Landschaften und kulinarische Genüsse auf eher langen Touren, auch mal mit Gepäck, haben bei Dir oberste Priorität. Lass Dich inspirieren und entdecke die schönsten Regionen auf Deinem corratec Traumbike.

Fantastic landscapes and culinary delights on longer tours, sometimes with luggage, are your top priority. Let yourself be inspired and discover the most beautiful regions on your corratec dream bike.



Du definierst Dich selbst als sportlich ambitionierter Radfahrer, suchst die persönliche Challenge und bist für jedes Abenteuer im Gelände oder auf der Straße zu haben! Deine Passion treibt Dich immer wieder an, neue Touren zu testen und neue Levels zu definieren.

Do you call yourself as a sporty, ambitious cyclist, are you looking for a personal challenge and are you always ready for any adventure on or off-road? Your passion drives you to try out new tours and routes, and to define your level again and again.



Höchstleistung ist Deine Devise. Die maximale Leistung Dein oberstes Ziel. Ein superleichtes corratec Rahmenset kombiniert mit hochwertigsten Komponenten ist für Dich die grundlegende Voraussetzung für den persönlichen Erfolg.

Top performance is your motto. Maximum performance is the ultimate goal. A super light corratec frame set combined with top quality components is the basic requirement for your personal success.

EINSATZBEREICHE

RANGE OF USE



Hierbei handelt es sich in der Regel um Kinderräder der Größe 12 und 16 Zoll, bestens geeignet für Kinder ab 3 Jahren. Diese Bikes sollten nur unter Aufsicht eines Erziehungsberechtigten und nicht im öffentlichen Verkehr eingesetzt werden.

These are usually children's bikes with 12 and 16 inch wheels, are suitable for children from 3 years old. These bikes should only be used under the supervision of a parent or legal guardian and not on public roads.



In diesem Bereich findest Du Fahrräder und Pedelecs des Typs Rennrad, Fitness und Urban. Diese Art von Bikes eignen sich hervorragend für asphaltierte Straßen und Wege, jedoch nicht für Drops, Sprünge oder Gelände.

In this range you will find bicycles and pedelecs for racing, fitness and urban cycling. These types of bikes are great for paved roads and paths, but not suitable for drops, jumps or off-road terrain.



Hier klassifiziert sind Fahrräder und Pedelecs des urbanen Bereichs und Stadtverkehrs. Sie unterstützen Dich als zuverlässigen Partner bei Deinen täglichen Pendelfahrten zur Arbeit oder in der Freizeit.

Bicycles and pedelecs in urban areas and city traffic are classified here. They are a reliable partner on your daily commute to work or in your free time.



Hier klassifiziert sind Fahrräder und Pedelecs des Typs Mountainbike, Gravel und all Track. Sie bieten Dir beste Performance in der Zielgruppe Cross Country, Marathon und Tour.

Mountain bike, gravel and all track bikes and e-bikes are classified here. They offer you the best performance for cross country, marathons and tours.



Um optimale Bedingungen für den Einsatzbereich Allmountain zu garantieren, ist ein Fahrrad oder ein (S) Pedelec des Typs Mountainbike dieser Kategorie empfehlenswert.

To guarantee optimal conditions for all-mountain use, a mountain bike or e-mountain bike of this category is recommended for riding in the Alps or for a Trans-Alp.



Fahrräder bzw. (S-) Pedelecs für extremes Gelände verlangt von den Fahrrädern bzw. (S-) Pedelecs höchste Anforderungen. Diese Art der Räder sind für den Bereich Enduro, Freeride und Downhill geeignet.

Mountain bikes or e-mountain bikes for extreme terrain place the highest demands on bicycle standards. These type of bikes are suitable for enduro, freeride and downhill riding..



26" WHEEL SIZE

26 Zoll Laufradgröße ist besonders für kleine Personen, welche ein sehr wendiges Bike suchen, geeignet.

—



650B WHEEL SIZE

650B Laufradgröße ist der neue MTB Standard. Das 650B Laufrad ist kein Kompromiss aus 26 und 29 Zoll. Es vereint in sich die Vorteile von 26 Zöllern (Gewicht, Torsionsteifigkeit und Agilität) mit den Vorteilen des 29" Laufrades (erhöhte Laufruhe, Überrollverhalten, erhöhte Kurvenstabilität).

—



28" WHEEL SIZE

28 Zoll rollen leichter als die 26-Zoll-Variante. Das 28" Rad benötigt zwar länger, um in Schwung zu kommen, rollt aber leichter und schneller über Steine und Wurzeln, was noch einen zusätzlichen Vorteil bringt – mehr Komfort.

—



WHEELSIZE SPLIT

Vorne 29 Zoll Laufräder, Hinten 650B + Bereifung. Die perfekte Kombination aus Rolleigenschaften, Handling und Agilität.

—



29" WHEEL SIZE

Große Laufräder rollen besser. 29 Zoll mit etwa acht Prozent weniger Energieaufwand als die 26-Zoll-Variante. Das 29" Rad benötigt zwar länger, um in Schwung zu kommen, rollt aber leichter und schneller über Steine und Wurzeln, was noch einen zusätzlichen Vorteil bringt – mehr Komfort.

—



PRESS FIT BB

Das Press Fit Lager ist leichter und durch den größeren Durchmesser des Kurbelgehäuses auch stabiler als herkömmliche Innenlager. Ausgeschlagene Gewinde gehören der Vergangenheit an.

26" WHEEL SIZE

26" wheel size is suitable for shorter people who are looking for a very versatile bike.

—

650B WHEEL SIZE

650B wheel size is the new MTB standard. The 650B wheel is not a compromise between 26 and 29". It combines the advantages of 26-inch models (weight, torsional stiffness and agility) with the advantages of 29" wheels (increased smoothness, rollover behavior, increased cornering stability).

—

28" WHEEL SIZE

28 inches roll easier than the 26-inch version. The 28" wheel takes longer to get going, but rolls easily and quickly over stones and roots, which still brings an additional advantage – greater comfort.

—

WHEELSIZE SPLIT

At the front 29 inch wheels, at the rear 650b + tyres. The perfect combination of rolling characteristics, handling and agility.

—

29" WHEEL SIZE

Large wheels roll better. 29 inches require about eight percent less energy than the 26-inch version. The 29" wheel takes longer to get going, but rolls easily and quickly over rocks and roots, which brings an additional advantage – more comfort.

—

PRESS FIT BB

The Press Fit bottom bracket is lighter and more stable thanks to the larger diameter of the bottom bracket. It is also more stable than a traditional bottom bracket. Worn out threads are a thing of the past.



DI2 READY

Der Rahmen ist standardmäßig schon auf die elektronische Schaltung von Shimano vorbereitet, falls Sie später auf diesen neuen Schaltungstyp umrüsten wollen.

—



STEM ADJUSTMENT

Der Vorbau ist vielseitig verstellbar. Durch Verstellung des Vorbauwinkels werden sowohl der Abstand Oberkörper zu Lenker, als auch die Lenkerhöhe verändert. Wer schmerzfrei fährt, fährt länger.

—



SUSPENSION SEATPOST

Die gefederte Sattelstütze bietet höchsten Komfort. Die Federhärte lässt sich auf Ihre Bedürfnisse einstellen.

—



HYBRID

Ein Pedelec (Pedal Electric Cycle) ist eine spezielle Ausführung eines Elektrofahrrades, bei dem der Fahrer von einem Elektroantrieb unterstützt wird, wenn er pedaliert.

—



TAPERED HEADTUBE

Das Steuerrohr ist speziell verstärkt um auftretenden Kräfte besser aufnehmen zu können.

—



DROPPER SEATPOST

Teleskopsattelstütze mit Bedienhebel am Lenker oder an der Sattelstütze.

—



INTERNAL CABLE ROUTING

Kabelverlegung im Inneren des Rahmens, zum Schutz und für ein elegantes Design.

DI2 READY

The frame is already prepared for Shimano electronic gear shifting by default, in case you want to update to this new type of gear shifting at a later date.

—

STEM ADJUSTMENT

The stem is fully adjustable. By adjusting the stem angle, both the distance upper body to handlebars, and the handlebar height are adjusted. Enjoy your long and pain free ride.

—

SUSPENSION SEATPOST

The suspension seatpost offers great comfort. The spring rate can be adjusted to your needs.

—

HYBRID

A pedelec (Pedal Electric Cycle) is a special version of an electric bicycle, where the rider is assisted by an electric drive unit when pedalling.

—

TAPERED HEADTUBE

The tapered head tube is specially reinforced to absorb the forces that occur more efficiently.

—

DROPPER SEATPOST

Dropper Seatpost with control lever on the handlebar or seatpost.

—

INTERNAL CABLE ROUTING

Internal Cable Routing inside the frame for better protection and a stylish design.



OPTIMIZED FOR DOUBLE

Die Kinematik des Bikes ist für 2-fach Kettenradgarnituren konstruiert und optimiert.

OPTIMIZED FOR DOUBLE

The kinematics of the bike are designed and optimised for double chainrings at the front.



THROUGH AXLE

„Through Axle“ haben den Vorteil, dass sie einen größeren Durchmesser als herkömmliche 9-mm-Achsen haben und so wesentlich steifer sind.

THROUGH AXLE

Through-axles have the advantage that they are larger in diameter than conventional 9 mm axles and as a result are significantly stiffer.



180 KG SYSTEMGEWICHT

Dank Shadow Edge Tube Technologie verfügt das Bike über den weltweit stabilsten und sichersten corratec E-Bike Rahmen und kann mit bis zu 180 Kg Systemgewicht belastet werden.

180 KG SYSTEM WEIGHT

The bike exhibits the world's most stable and safest corratec e-Bike frame and can carry up to a total of 180 kg system weight.

TECHNOLOGIEN —TECHNOLOGIES—

TECHNIK MACHT DEN UNTERSCHIED **TECHNOLOGY MAKES THE DIFFERENCE**

Seit vielen Jahren begeistern wir unsere Kunden, erstaunen andere Wettbewerber und rufen Nachahmer hervor. Kaum ein anderes Produkt trägt so viele nützliche Features und Innovationen in sich wie ein corratec Bike. Dies spürst Du bei jeder Pedalumdrehung.

For many years we have been inspiring our customers, astounding competitors and evoking imitators. Hardly any other product carries as many useful innovations as a corratec bike. Feel the passion with every pedal turn.



E-MOUNTAINBIKE

Raus aus dem Alltag und rein ins Grüne! Mit unseren E-MTBs garantieren wir Dir neue Abenteuer und Faszination pur. Bergauf auf befestigten Wegen oder bergab auf anspruchsvollen Trails bieten wir Dir jede Menge Spaß und Sicherheit. Mit unseren superleichten E-MTB Fullys und Hardtails erzielst Du maximale Performance, Dynamik und kommst sicher über die Alpen. Neueste Technologien um neue Grenzen zu setzen.

Take a break from everyday life and get out into the countryside! Our E-MTBs guarantee you new adventures and fascinating experiences. Whether it's riding up steep climbs or down demanding trails, our bikes offer you lots of fun and safety. With our superlight full suspension and hardtail e-mountain bikes you'll get maximum performance to get you across the Alps safely. All e-mountain bikes offer the latest technologies to help push you to your limits.

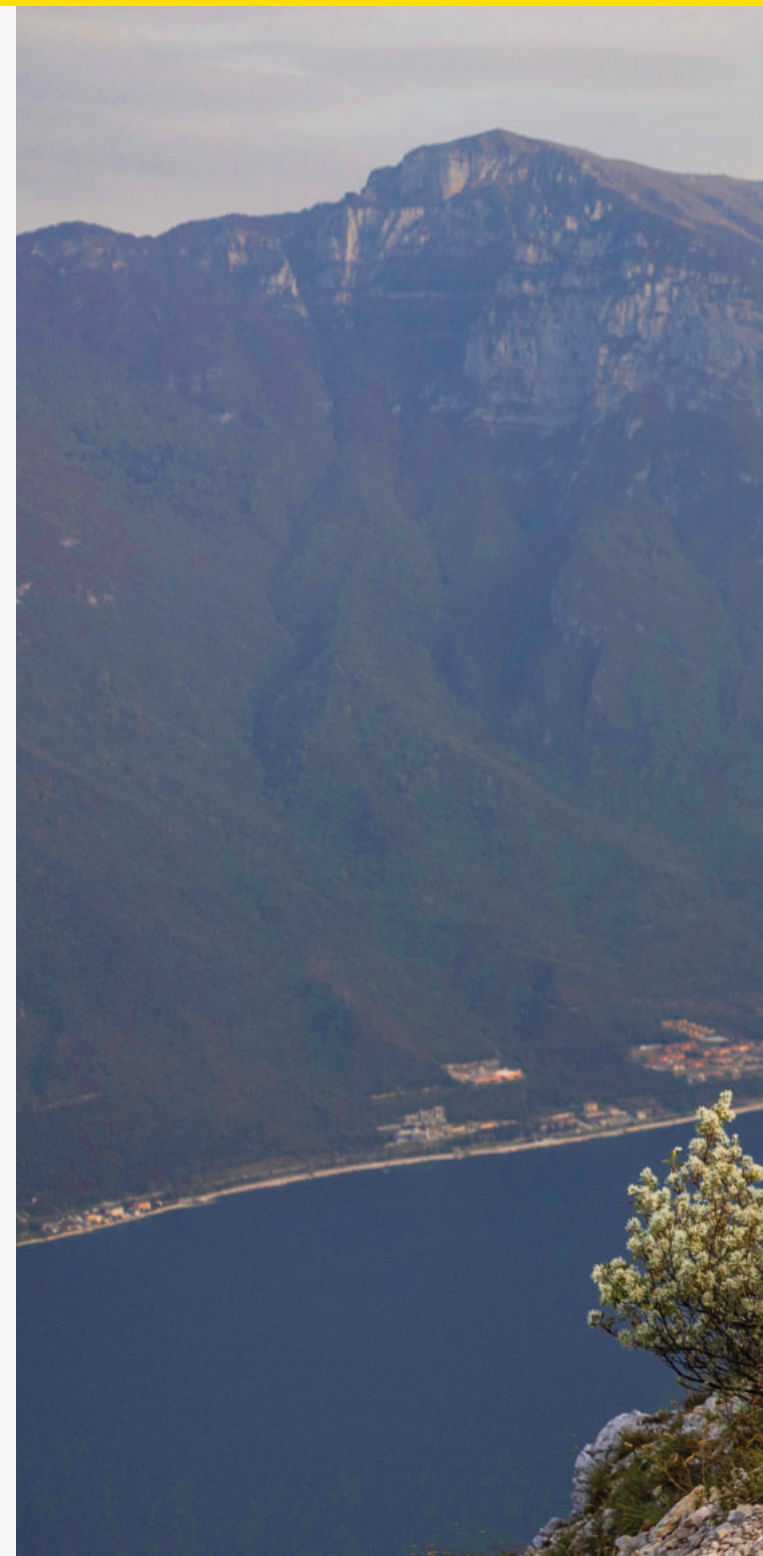



E-POWER iLINK 180



3.345_{GR}

Voll Carbon Rahmen
Full Carbon Frame

iLINK

Maximaler Vortrieb
und Traktion

Maximum propulsion
and traction

180_{MM}

Maximale Federung bei
maximalen Vortrieb

Maximum suspension with
maximum propulsion



iLINK TECHNOLOGIE

Diese einzigartige Innovation, zu 100% im Hause corratec konstruiert und entwickelt, ermöglicht es Dir Deinen Hinterbau und Dämpfer zu jeder Zeit auch uphill, geöffnet zu lassen.

- Automatischer Lockout
- Maximaler Vortrieb
- Bessere Traktion

This unique innovation, designed and developed 100% by corratec, enables you to keep your rear shock open at all times, even uphill.

- Automatic lockout
- Maximum traction
- Maximum propulsion

SMART CHARGE SYSTEM

Die brandneue, im Oberrohr des Rahmens integrierte Ladebuchse erleichtert Dir das Laden Deines Akkus und ist dazu noch ein echter Hingucker.

The brand new charging socket integrated into the top tube of the frame makes it easier for you to charge your battery and gives your bike a cleaner look.





E-POWER iLINK 180 FACTORY

Ultraleichter Carbon Rahmen inklusive Carbon Hinterbau mit 180 mm Federweg. Ultralight carbon frame including carbon rear triangle with 180 mm travel.

Alle herausragenden Features der iLink Technologie nun auch im E-Bike. A downhill machine that ensures amazing pleasure on all trails of the world.

625

Wh

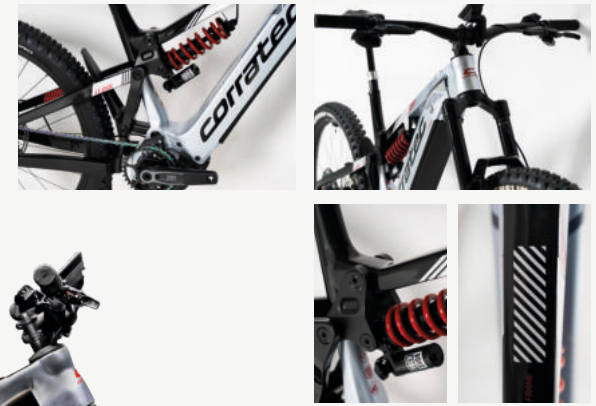

- Bosch CX-R BES3
- Bosch PowerTube 625Wh
- Bosch Kiox 300 Display
- E-Power iLink
- RS ZEB Ultimate RC2 29" Boost 180mm
- RS Super Deluxe Coil Ultimate RCT 205X65
- SRAM X01 Eagle AXS RED
- SRAM GX Eagle AXS
- SRAM Code Silver Stealth 4-piston 203 mm
- SRAM Code Silver Stealth 4-piston 203 mm
- SRAM X-SYNC 2 34T
- SRAM XG 1299 Eagle 10-52T Rainbow
- CN XX1 Eagle Rainbow
- DT Swiss HX 1501 Spline@ 29" I Front
- DT Swiss HX 1501 Spline@ 650B I Rear
- Michelin E-Wild I Front
- Michelin E-Wild I Rear
- SELLE SAN MARCO, Gnd Full-fit Start Up
- SRAM SP Reverb AXS 31.6mm
- ZZYZX SL Alloy Stem
- ZZYZX Mountain Handlebar 800 mm wide

FARBE COLOR



Silver Gray | Pearlized Black | Race Red | Metallic Anthracite

BK29410

RAHMEN FRAME

E-POWER I-LINK 180

FEATURES

42 | 48 | 52

VVP RRP **12.499 EUR**

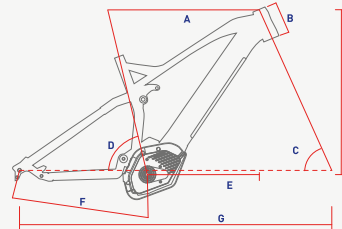

CM	A	B	C	D	E	F	G	H
42	599	86	65	77	1236	445	455	616
48	611	97	65	77	1248	445	465	621
52	623	106	65	77	1262	445	475	629



Bilder dienen nur als Veranschaulichung
Images are for illustrative purposes only

E-POWER iLINK 180 PRO

Ultraleichter Carbon Rahmen inklusive Carbon Hinterbau mit 180 mm Federweg. Ultralight carbon frame including carbon rear triangle with 180 mm travel.

Alle herausragenden Features der iLink Technologie nun auch im E-Bike. A downhill machine that ensures amazing pleasure on all trails of the world.

625 Wh

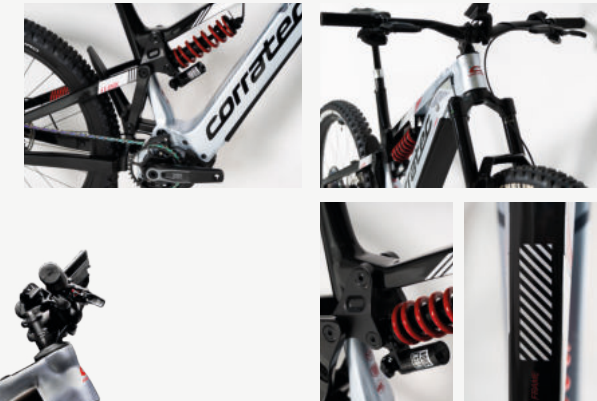

- Bosch CX-R BES3
- Bosch PowerTube 625Wh
- Bosch Kiox 300 Display
- E-Power iLink
- RockShox ZEB RC 29" Boost 180 mm
- RockShox Super Deluxe Coil Select R
- SRAM X01 Eagle
- Sram GX Eagle Single Click
- Sram G2 R 4-piston 203 mm
- Sram G2 R 4-piston 203 mm
- Sram X-SYNC 2 34T
- Sram XG 1275 Eagle 10-50T
- CN SX EAGLE
- DT Swiss H 1900 Spline@ 29" I Front
- DT Swiss H 1900 Spline@ 650B I Rear
- Michelin E-Wild I Front
- Michelin E-Wild I Rear
- SELLE SAN MARCO Gnd Full-fi t Start Up
- Kindshock RAGEi 31.6 mm
- ZZYZX SL Alloy Stem
- ZZYZX Mountain Handlebar 800 mm wide

FARBE COLOR



Silver Gray | Pearlized Black | Race Red | Metallic Anthracite

BK29412

RAHMEN FRAME

E-POWER I-LINK 180

FEATURES

42 | 48 | 52

UVP RRP 8.699 EUR

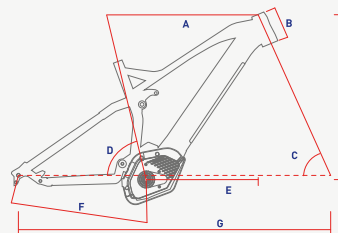

CM	A	B	C	D	E	F	G	H
42	599	86	65	77	1236	445	455	616
48	611	97	65	77	1248	445	465	621
52	623	106	65	77	1262	445	475	629



Bilder dienen nur als Veranschaulichung
Images are for illustrative purposes only



E-POWER iLINK 180 RACE

Ultraleichter Carbon Rahmen inklusive Carbon Hinterbau mit 180 mm Federweg. Ultralight carbon frame including carbon rear triangle with 180 mm travel.

Alle herausragenden Features der iLink Technologie nun auch im E-Bike. A downhill machine that ensures amazing pleasure on all trails of the world.

625_{Wh}

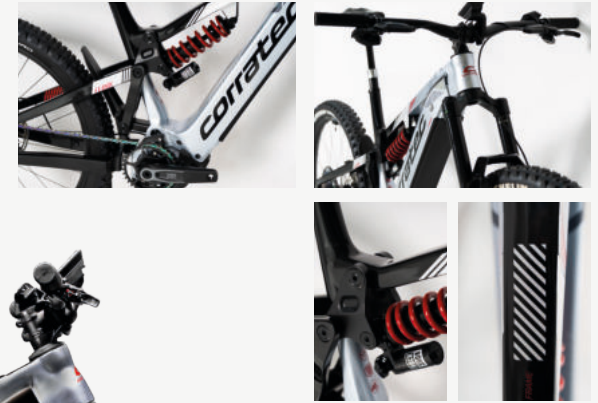

- Bosch CX-Race
- Bosch PowerTube 625Wh
- Bosch Purion 200 Display
- E-Power iLink
- RockShox Yari Motion Control RC 29" B 180 mm
- RockShox Super Deluxe Coil Select R
- Sram GX Eagle Lunar
- Sram NX Eagle
- Sram GUIDE T 4-piston 203 mm
- Sram GUIDE T 4-piston 203 mm
- Sram X-SYNC 2 34T
- Sram PG1210 Eagle 11-50T
- CN SX EAGLE
- ZZYZX X30 29" I Front
- ZZYZX X30 650B I Rear
- Michelin E-Wild I Front
- Michelin E-Wild I Rear
- SELLE SAN MARCO, Gnd Full-fit Start Up
- Kindshock RAGEi 31.6 mm
- ZZYZX SL Alloy Stem
- ZZYZX Mountain Handlebar 800 mm wide

FARBE COLOR



Silver Gray | Pearlized Black | Race Red | Metallic Anthracite

BK29413

RAHMEN FRAME

E-POWER I-LINK 180

FEATURES

42 | 48 | 52

UVP RRP **7.699 EUR**

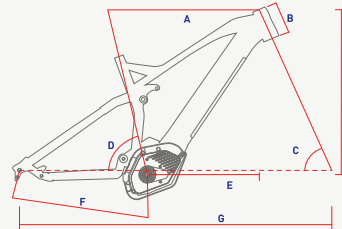

CM	A	B	C	D	E	F	G	H
42	599	86	65	77	1236	445	455	616
48	611	97	65	77	1248	445	465	621
52	623	106	65	77	1262	445	475	629



Bilder dienen nur als Veranschaulichung
Images are for illustrative purposes only

E-POWER RS 160 FACTORY

Der Triple Butted Aluminium Rahmen sorgt für ein leichtes und stabiles E-Bike. Triple butted aluminum frame for a light and stiff E-Bike.

Die Shadow Edge Tube 3.0 Technologie gibt dem Rahmen höchstmögliche Steifigkeit. Shadow Edge Tube 3.0 – world's stiffest corrated E-Bike frame.

Die spezielle Allmountain Geometrie eignet sich optimal für lange Touren im Gelände. The special all-mountain geometry is perfect for long tours in the Alps.

750
Wh

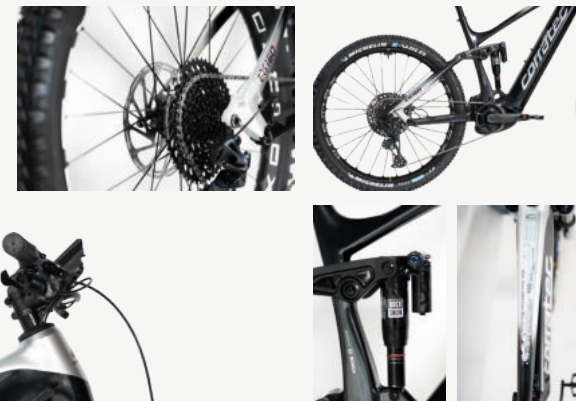

- Bosch CX Cruise BES3
- Bosch PowerTube 750Wh
- Bosch Kiox 300 Display
- E-Power RS160
- RockShox ZEB Ultimate RC2 29" Boost 160 mm
- RockShox Super Deluxe Ultimate RCT
- SRAM GX
- SRAM GX Eagle
- SRAM Code Bronze Stealth 4-piston 203 mm
- SRAM Code Bronze Stealth 4-piston 203 mm
- Sram X-SYNC 2 34T
- Sram XG1275 Eagle 10-50T
- CN SX EAGLE
- Mavic E-Deemax S30 29" I Front
- Mavic E-Deemax S30 650B I Rear
- Michelin E-Wild I Front
- Michelin E-Wild I Rear
- SELLE SAN MARCO, Gnd Full-fit Start Up
- Kindshock RAGE-i 30.9mm
- ZZYZX SL Alloy Stem
- ZZYZX Mountain Handlebar 800 mm wide

FARBE COLOR

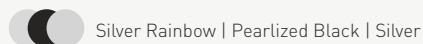

BK29420

RAHMEN FRAME

E-POWER RS 160 | SHADOW EDGE TUBE 3.0

FEATURES

39 | 42 | 47 | 52

UVP RRP **7.799 EUR**

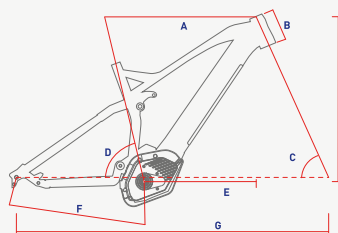

CM	A	B	C	D	E	F	G	H
39	565	115	65	78	1225	464	440	620
42	588	125	65	78	1249	464	460	629
47	615	135	65	78	1278	464	485	638
52	644	150	65	78	1310	464	510	652



Bilder dienen nur als Veranschaulichung
Images are for illustrative purposes only

E-POWER RS 160 PRO TEAM

Der Triple Butted Aluminium Rahmen sorgt für ein leichtes und stabiles E-Bike. High-quality frame with triple butted aluminum for a light and stiff E-Bike.

Die Shadow Edge Tube 3.0 Technologie gibt dem Rahmen höchstmögliche Steifigkeit. Shadow Edge Tube 3.0 – worldwide most stable and safest corratec E-Bike frame with integrated battery.

Die spezielle Allmountain Geometrie eignet sich optimal für lange Touren im Gelände. The special all-mountain geometry fits perfectly for long tours across the alps.

750

Wh

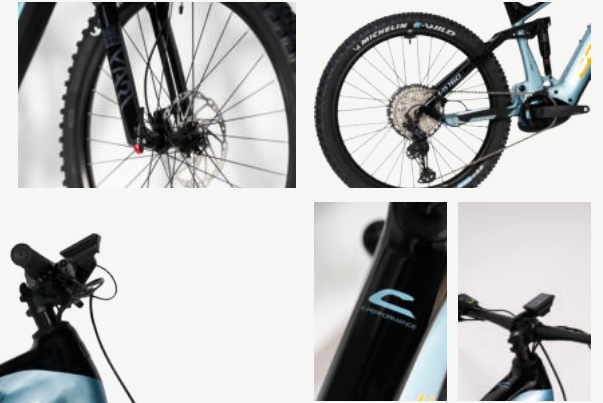

E-RS 160

- Bosch Performance CX Cruise BES3 (25 km/h)
- Bosch Power Tube 750Wh
- Bosch Kiox 300
- E-Power RS 160 Boost
- Rockshox FS Yari RC 29" 160mm
- Rockshox Deluxe Select+
- Shimano Deore XT SGS 12S
- Shimano SLX 12S
- Shimano MT420 203mm I Front
- Shimano MT420 203mm I Rear
- ZZYZX E-Power Crank 34T
- Shimano SLX 10-51T 12S
- KMC X12 12S
- ZZYZX X30 29" I Front
- ZZYZX X30 650B I Rear
- Michelin E-Wild I Front
- Michelin E-Wild I Rear
- Selle Italia Model X3 XP BOOST Superflow
- Kindshock 900i 30.9mm
- ZZYZX SL Alloy Stem
- ZZYZX Mountain Handlebar 800 mm wide

FARBE COLOR



Blue | Green | Mnova Chrome | Pearlized Black

BK29421

RAHMEN FRAME

E-POWER RS 160 | SHADOW EDGE TUBE 3.0

FEATURES

39 | 42 | 47 | 52

VVP RRP **6.499 EUR**

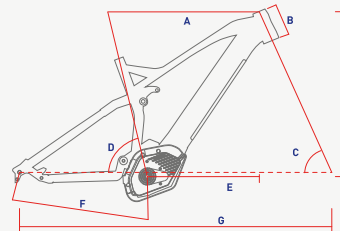

CM	A	B	C	D	E	F	G	H
39	613	145	65	74	1223	449	425	655
42	633	145	65	74	1243	449	445	655
47	654	150	65	74	1266	449	465	660
52	677	160	65	74	1290	449	485	669



Bilder dienen nur als Veranschaulichung
Images are for illustrative purposes only

E-POWER RS 160 PRO

Der Triple Butted Aluminium Rahmen sorgt für ein leichtes und stabiles E-Bike. Triple butted aluminum frame for a light and stiff E-Bike.

Die Shadow Edge Tube 3.0 Technologie gibt dem Rahmen höchstmögliche Steifigkeit. Shadow Edge Tube 3.0 – world's stiffest corrated E-Bike frame.

Die spezielle Allmountain Geometrie eignet sich optimal für lange Touren im Gelände. The special all-mountain geometry is perfect for long tours in the Alps.

625 Wh

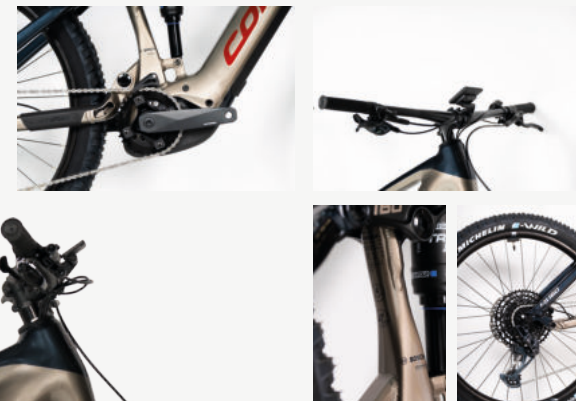

- Bosch Performance CX Cruise BES3 (25 km/h)
- Bosch Power Tube 625Wh
- Bosch Intuvia 100
- E-Power RS 160 Boost
- SR Suntour DuroLux 36 RC2 160mm
- SR Suntour TRIAir2
- SRAM GX 12s
- SRAM GX 12s
- Shimano MT420 203mm | Front
- Shimano MT420 203mm | Rear
- ZZYX E-Power Crank 34T
- SRAM PG1230 12s 11-5B
- SRAM SX 12s
- ZZYX X30 29" | Front
- ZZYX X30 650B | Rear
- Michelin E-Wild 29" x 2.60 | Front
- Michelin E-Wild 650B x 2.80 | Rear
- Selle ItaliaX3 XP BOOST Superflow
- Kindshock 900i 30.9mm
- ZZYX SL Alloy Stem
- ZZYX Mountain Handlebar 800 mm wide

FARBE COLOR

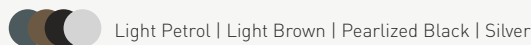

BK29422

RAHMEN FRAME

E-POWER RS 160 | SHADOW EDGE TUBE 3.0

FEATURES

39 | 42 | 47 | 52

UVP RRP 5.999 EUR

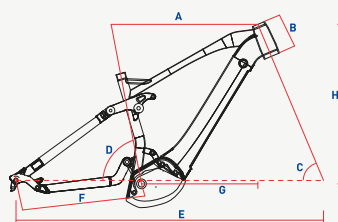

CM	A	B	C	D	E	F	G	H
39	613	145	65	74	1223	449	425	655
42	633	145	65	74	1243	449	445	655
47	654	150	65	74	1266	449	465	660
52	677	160	65	74	1290	449	485	669



Bilder dienen nur als Veranschaulichung
Images are for illustrative purposes only

E-POWER RS 160 ELITE

Der Triple Butted Aluminium Rahmen sorgt für ein leichtes und stabiles E-Bike. High-quality frame with triple butted aluminum for a light and stiff E-Bike.

Die Shadow Edge Tube 3.0 Technologie gibt dem Rahmen höchstmögliche Steifigkeit. Shadow Edge Tube 3.0 – worldwide most stable and safest corrated E-Bike frame with integrated battery.

Die spezielle Allmountain Geometrie eignet sich optimal für lange Touren im Gelände. The special all-mountain geometry fits perfectly for long tours across the alps.

625

Wh



- Bosch Performance CX Cruise BES3 (25 km/h)
- Bosch Power Tube 625Wh
- Bosch Purion 200
- E-Power RS 160 Boost
- SR Suntour AION EVO 35-Boost 160mm
- SR Suntour EDGE LOR
- Sram SX Eagle 12S
- Sram SX Eagle 12S
- Tektro HDM-275 203mm I Front
- Tektro HDM-275 203mm I Rear
- Sram X-Sync 34T
- Sram PG1210 Eagle 11-50T 12S
- Sram SX Eagle 12S
- ZZYZX X30 29" I Front
- ZZYZX X30 650B I Rear
- Michelin E-Wild I Front
- Michelin E-Wild I Rear
- Selle Italia X3 XP BOOST Superflow
- Kindshock 900i 30.9mm
- ZZYZX SL Alloy Stem
- ZZYZX SL Alloy Handlebar

FARBE COLOR



Tactic Green | Silver Gray | Pearlized Black

BK29423

RAHMEN FRAME

E-POWER RS 160 | SHADOW EDGE TUBE 3.0

FEATURES

39 | 42 | 47 | 52

VVP RRP **4.999 EUR**

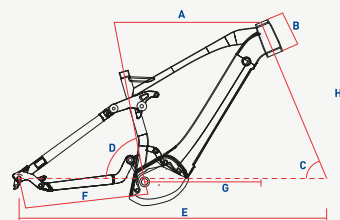

CM	A	B	C	D	E	F	G	H
39	613	145	65	74	1223	449	425	655
42	633	145	65	74	1243	449	445	655
47	654	150	65	74	1266	449	465	660
52	677	160	65	74	1290	449	485	669























Das Rendering dient nur als Referenz
The Rendering is for Reference only

E-POWER RS 140 EL PRO

E-Fully mit 150 mm Federweg - für alle, die E-Power und wahre Muskelkraft auf dem Trail kombinieren möchten. E-Fully with 150 mm suspension - for all those, who want to combine E-Power and real muscle power on the trails.

Bosch PL SX 400 Wh Motor kann je nach Bedarf durch On/Off-Schalter am Oberrohr dosiert zugeschaltet werden. Bosch PL SX 400 Wh motor can be switched on or off via a switch on the top tube.

Vereint Sportlichkeit, Leichtigkeit und Dynamik mit Reichweite und E-Power. Combines sportiness, effortlessness and dynamics with range and E-Power.

-  Bosch Performance Line SX
-  Bosch Compact Tube 400 Wh + Range Extender Ready
-  Bosch Purion 200
-  E-Power RS 140 EL Pro
-  RockShox Lyrik Select+ Charger 3 RC2 29" 150mm
-  RockShox Deluxe Select+ RT 205X65
-  Sram GX Eagle
-  Sram GX Eagle
-  Sram Code Bronze Stealth 4-Piston 203 mm
-  Sram Code Bronze Stealth 4-Piston 180 mm
-  Sram X-SYNC 2 34T
-  Sram XG 1275 EAGLE 10-50T
-  CN SX Eagle
-  MAVIC Crossmax XL 29" XD I Front
-  Mavic Crossmax XL 29" XD I Rear
-  Schwalbe Nobby Nic I Front
-  Schwalbe Nobby Nic I Rear
-  SELLE SAN MARCO Gnd Full-fit Start Up
-  Kindshock RAGEi, 30.9 mm x 445 mm
-  ZZZZX SL Alloy Stem
-  ZZZZX Mountain Handlebar



FARBE COLOR

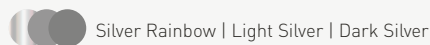

BK29418

 41 | 43 | 46 | 49

UVP RRP 6.599 EUR

RAHMEN FRAME

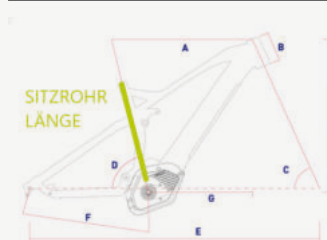

E-POWER RS 140

CM	A	B	C	D	E	F	G	H
39	590	115	65	77	1225	464	440	620
42	623	125	65	77	1249	464	460	629
47	662	135	65	77	1278	464	485	638
52	701	150	65	77	1310	464	510	652

FEATURES



Bilder dienen nur als Veranschaulichung
Images are for illustrative purposes only

E-POWER X VERT FACTORY

Komfort und Grip dank Wheel Split – vorne 29 Zoll Reifen und hinten 650B+. Wheel Split – Front 29 inch and Rear 650B+ tyres offer comfort and grip.

Trail Hardtail mit 140mm Federweg und einem flacheren Lenkwinkel. Trail hardtail with 140 mm travel and a flatter steering head angle.

Shadow Edge Tube 3.0 – 750 Wh Bosch Akku elegant verpackt im Unterrohr. Shadow Edge Tube 3.0 for an elegant integration of the 750Wh Bosch battery.

750 Wh

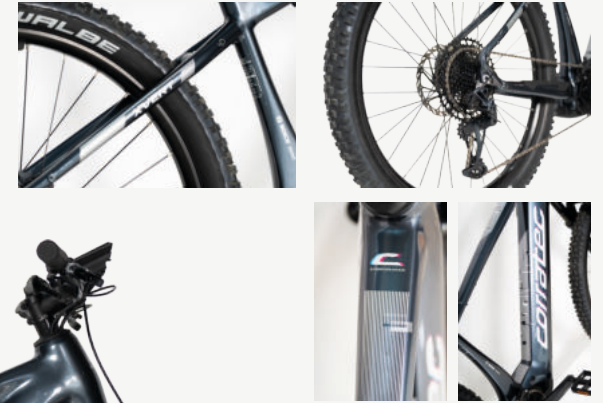

- Bosch CX Cruise BES3
- Bosch PowerTube 750 Wh
- Bosch Kiox 300 Display
- E-Power X Vert
- RockShox Revelation 29" 140 mm
- Sram GX Eagle Lunar
- Sram GX Eagle
- SRAM Level Bronze Stealth 4P 203mm
- SRAM Level Bronze Stealth 4P 180mm
- Sram X-SYNC 2 34T
- Sram PG1210 Eagle 11-50T
- CN SX EAGLE
- ZZZZX 29" I Front
- ZZZZX 650B I Rear
- Schwalbe Nobby Nic I Front
- Schwalbe Nobby Nic I Rear
- SELLE ITALIA; X3 XP BOOST Superflow
- Kindshock RAGE-i 30.9mm
- ZZZZX SL Alloy Stem
- ZZZZX Mountain Handlebar

FARBE COLOR

Dark Gray | Silver

BK29400

RAHMEN FRAME

E-POWER X VERT | SHADOW EDGE TUBE 3.0

FEATURES

44 | 49 | 54 | 57

UVP RRP **5.499 EUR**

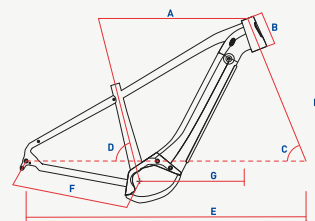

CM	A	B	C	D	E	F	G	H
44	635	145	66	73	1212	455	430	672
49	650	145	66	73	1227	455	445	672
54	667	150	66	73	1244	455	460	677
57	685	160	66	73	1263	455	475	686



Bilder dienen nur als Veranschaulichung
Images are for illustrative purposes only

E-POWER X-VERT PRO TEAM

Komfort und Grip dank Wheel Split – vorne 29 Zoll Reifen und hinten 650B+. Wheel Split – Front 29 inch and Rear 650B+ tyres offer comfort and grip.

Trail Hardtail mit 120mm Federweg und einem flacheren Lenkwinkel. Trail hardtail with 120 mm travel and a flatter steering head angle.

Shadow Edge Tube 3.0 – 750 Wh Bosch Akku elegant verpackt im Unterrohr. Shadow Edge Tube 3.0 for an elegant integration of the 750Wh Bosch battery.

750
Wh

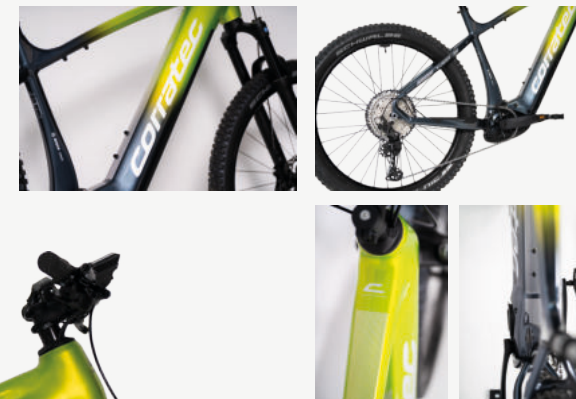

- Bosch CX Cruise BES3
- Bosch PowerTube 750 Wh
- Bosch Kiox 300 Display
- E-Power X Vert
- SR Suntour RAIDON34X-Boost EQ 2CR 29" 120 mm
- Shimano Deore XT SGS 12S
- Shimano Deore SLX SGS 12S
- Shimano MT420 4 piston 180 mm
- Shimano MT410 2 piston 180 mm
- ZZYX E-Power Crank 34T
- Shimano SLX 12S 10-51T
- KMC X12
- ZZYX 29" I Front
- ZZYX 650B I Rear
- Schwalbe Nobby Nic I Front
- Schwalbe Nobby Nic I Rear
- SELLE ITALIA; X3 XP BOOST Superfl ow
- Kindshock RAGEi Suspension 30.9 mm
- ZZYX SL Alloy Stem
- ZZYX Mountain Handlebar

FARBE COLOR Green | Dark Gray | Silver

BK29401

RAHMEN FRAME

E-POWER X VERT | SHADOW EDGE TUBE 3.0

FEATURES

44 | 49 | 54 | 57

UVP RRP **4.899 EUR**

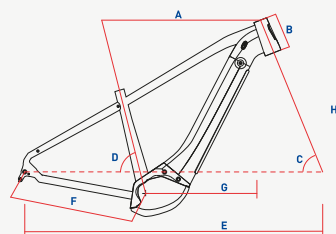

CM	A	B	C	D	E	F	G	H
44	635	145	66	73	1212	455	430	672
49	650	145	66	73	1227	455	445	672
54	667	150	66	73	1244	455	460	677
57	685	160	66	73	1263	455	475	686



Das Rendering dient nur als Referenz
The Rendering is for Reference only

E-POWER X VERT PRO SPORT

Komfort und Grip dank Wheel Split – vorne 29 Zoll Reifen und hinten 650B+. Wheel Split – Front 29 inch and Rear 650B+ tyres offer comfort and grip.

Trail Hardtail mit 120mm Federweg und einem flacheren Lenkwinkel. Trail hardtail with 120 mm travel and a flatter steering head angle.

Shadow Edge Tube 3.0 – 750 Wh Bosch Akku elegant verpackt im Unterrohr. Shadow Edge Tube 3.0 for an elegant integration of the 750Wh Bosch battery.

750 Wh



Das Rendering dient nur als Referenz
The Rendering is for Reference only

- Bosch Performance CX Cruise BES3 (25 km/h)
- Bosch Power Tube 750Wh
- Purion 200
- E-Power X Vert Boost Trapez
- SR Suntour XCR32-Boost-AIR LOR DS 29" 120mm
- Shimano Deore XT 11S
- Shimano SLX 11S
- Shimano Deore 5100 11s 11-42T
- Shimano MT420 180mm I Front
- Shimano MT410 180mm I Rear
- ZZYZX E-Power Crank 34T
- Shimano SLX 11-46T 11S
- KMC X11 11S
- ZZYZX Cross Attack 29" I Front
- ZZYZX Cross Attack 650B I Rear
- Schwalbe Smart Sam 57-622 I Front
- Schwalbe Smart Sam 70-584 I Rear
- Corratec sport saddle
- ZZYZX Suspension Seatpost 30.9mm
- ZZYZX SL Alloy Stem
- ZZYZX SL Alloy Handlebar

FARBE COLOR

Dark Red | Bronze brown | Silver Gray

BK29402

RAHMEN FRAME

E-POWER X VERT SPORT | SHADOW EDGE TUBE 3.0

FEATURES

39 | 44 | 49 | 54

UVP RRP **4.499 EUR**

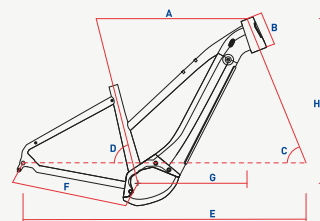

CM	A	B	C	D	E	F	G	H
39	635	145	66	73	1212	455	430	672
44	650	145	66	73	1227	455	445	672
49	667	150	66	73	1244	455	460	677
54	685	160	66	73	1263	455	475	686



E-POWER X-VERT PRO GENT

Komfort und Grip dank Wheel Split – vorne 29 Zoll Reifen und hinten 650B+. Wheel Split – Front 29 inch and Rear 650B+ tyres offer comfort and grip.

120mm Federweg für viel Fahrspaß und Sicherheit auf schnellen Abfahrten mit losem Untergrund. 120mm travel ensures riding pleasure and safety on high speed descents.

Shadow Edge Tube 3.0 – 750 Wh Bosch Akku elegant verpackt im Unterrohr. Shadow Edge Tube 3.0 for an elegant integration of the 750Wh Bosch battery.

750
Wh

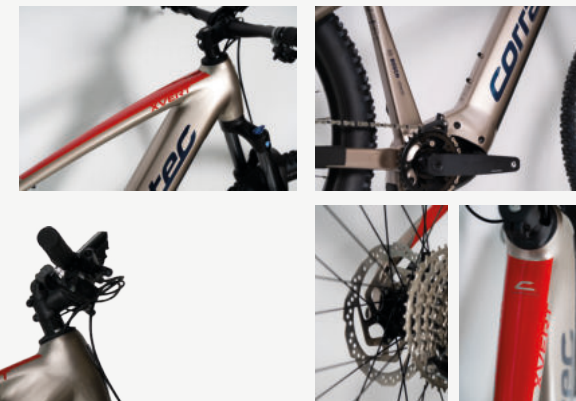

- Bosch Performance CX Cruise BES3 (25 km/h)
- Bosch Power Tube 750Wh
- Purion 200
- E-Power X Vert Boost Gent
- SR Suntour XCR32-Boost-AIR LOR DS 29" 120mm
- Deore XT 11s
- Shimano SLX 11S
- Shimano Deore 5100 11s 11-42T
- Shimano MT420 180mm I Front
- Shimano MT410 180mm I Rear
- ZZYZX E-Power Crank 34T
- Shimano SLX 11-46T 11S
- KMC X11 11S
- ZZYZX X Vert 29" I Front
- ZZYZX X Vert 650B I Rear
- Schwalbe Smart Sam 57-622 I Front
- Schwalbe Smart Sam 70-584 I Rear
- corratec sport saddle
- ZZYZX Suspension Seatpost 30.9mm
- ZZYZX SL Alloy Stem
- ZZYZX SL Alloy Handlebar

FARBE COLOR

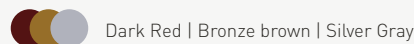

BK29403

RAHMEN FRAME

E-POWER X VERT GENT | SHADOW EDGE TUBE 3.0

FEATURES

44 | 49 | 54 | 57

UVP RRP **4.499 EUR**

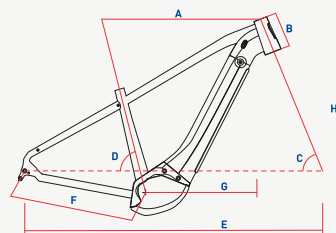

CM	A	B	C	D	E	F	G	H
44	635	145	66	73	1212	455	430	672
49	650	145	66	73	1227	455	445	672
54	667	150	66	73	1244	455	460	677
57	685	160	66	73	1263	455	475	686



Das Rendering dient nur als Referenz
The Rendering is for Reference only

E-POWER X VERT ELITE SPORT

Komfort und Grip dank Wheel Split – vorne 29 Zoll Reifen und hinten 650B+. Wheel Split – Front 29 inch and Rear 650B+ tyres offer comfort and grip.

120mm Federweg für viel Fahrspaß und Sicherheit auf schnellen Abfahrten mit losem Untergrund. 120mm travel for plenty of riding pleasure and safety on technical trails.

Die Shadow Edge Tube 3.0 Technologie gibt dem Rahmen höchstmögliche Steifigkeit. Shadow Edge Tube 3.0 – worldwide most stable and safest corrated E-Bike frame with integrated battery.

625

Wh



- Bosch Performance CX Cruise BES3 (25 km/h)
- Bosch Power Tube 625Wh
- Bosch Intuvia 100
- E-Power X Vert Boost Trapez
- SR Suntour XCR32-Boost-AIR LOR DS 29" 120mm
- Shimano Deore SGS 11S
- Shimano Deore RD-M5120 11s
- Shimano Deore 5100 11s 11-42T
- Shimano MT420 180mm I Front
- Shimano MT410 180mm I Rear
- ZZYZX E-Power Crank 34T
- Shimano Deore 11-42T 11S
- KMC X11 11S
- ZZYZX X Vert 29" I Front
- ZZYZX X Vert 650B I Rear
- Schwalbe Smart Sam 57-622 I Front
- Schwalbe Smart Sam 70-584 I Rear
- corrated sport saddle
- ZZYZX Suspension Seatpost 30.9mm
- ZZYZX SL Alloy Stem
- ZZYZX SL Alloy Handlebar

FARBE COLOR

White-Blue | Orange | Dark Blue

BK29404

RAHMEN FRAME

E-POWER X VERT SPORT | SHADOW EDGE TUBE 3.0

FEATURES

39 | 44 | 49 | 54

VVP RRP **3.999 EUR**

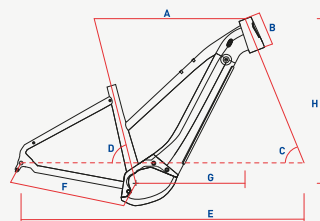

CM	A	B	C	D	E	F	G	H
39	617	150	66	73	1194	455	410	677
44	632	150	66	73	1209	455	425	677
49	650	160	66	73	1228	455	440	686
54	667	170	66	73	1247	455	455	695



Das Rendering dient nur als Referenz
The Rendering is for Reference only

E-POWER X-VERT ELITE GENT

Komfort und Grip dank Wheel Split – vorne 29 Zoll Reifen und hinten 650B+. Wheel Split – Front 29 inch and Rear 650B+ tyres offer comfort and grip.

120mm Federweg für viel Fahrspaß und Sicherheit auf schnellen Abfahrten mit losem Untergrund. 120mm travel ensures riding pleasure and safety on high speed descents.

Die Shadow Edge Tube 3.0 Technologie gibt dem Rahmen höchstmögliche Steifigkeit. Shadow Edge Tube 3.0 – worldwide most stable and safest corrateg E-Bike frame with integrated battery.

625
Wh



- Bosch Performance CX Cruise BES3 (25 km/h)
- Bosch Power Tube 625Wh
- Bosch Intuvia 100
- E-Power X Vert Boost Gent
- SR Suntour XCR32-Boost-AIR LOR DS 29" 120mm
- Shimano Deore SGS 11s
- Shimano Deore RD-M5120 11s
- Shimano Deore 5100 11s 11-42T
- Shimano MT420 180mm | Front
- Shimano MT410 180mm | Rear
- ZZZZX E-Power Crank 34T
- Shimano Deore 11-42T 11S
- KMC X11 11S
- ZZZZX X Vert 29" | Front
- ZZZZX X Vert 650B | Rear
- Schwalbe Smart Sam 57-622 | Front
- Schwalbe Smart Sam 70-584 | Rear
- corrateg sport saddle
- ZZZZX Suspension Seatpost 30.9mm
- ZZZZX SL Alloy Stem
- ZZZZX SL Alloy Handlebar

FARBE COLOR



Silver Light Green | Turquoise Green | Dark Blue

BK29405

RAHMEN FRAME

E-POWER X VERT GENT | SHADOW EDGE TUBE 3.0

FEATURES

44 | 49 | 54 | 57

UVP RRP **3.999 EUR**

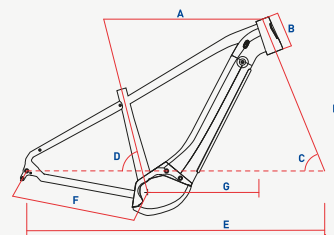

CM	A	B	C	D	E	F	G	H
44	617	150	66	73	1194	455	410	677
49	632	150	66	73	1209	455	425	677
54	650	160	66	73	1228	455	440	686
57	667	170	66	73	1247	455	455	695



Das Rendering dient nur als Referenz
The Rendering is for Reference only

E-POWER X VERT RACE SPORT

Komfort und Grip dank Wheel Split – vorne 29 Zoll Reifen und hinten 650B+. Wheel Split – Front 29 inch and Rear 650B+ tyres offer comfort and grip.

120mm Federweg für viel Fahrspaß und Sicherheit auf schnellen Abfahrten mit losem Untergrund. 120mm travel for plenty of riding pleasure and safety on technical trails.

Die Shadow Edge Tube 3.0 Technologie gibt dem Rahmen höchstmögliche Steifigkeit. Shadow Edge Tube 3.0 – worldwide most stable and safest corratec E-Bike frame with integrated battery.

625

Wh



- Bosch Performance CX Cruise BES3 (25 km/h)
- Bosch Power Tube 625Wh
- Bosch Purion 200
- E-Power X Vert Boost Trapez
- SR Suntour XCM32 Boost LOR 29" 120mm
- Sram SX Eagle 12S
- Sram SX Eagle 12S
- Tektro HD-M275 180mm I Front
- Tektro HD-M275 180mm I Rear
- Sram X-Sync 34T
- Sram PG1210 Eagle 11-50T 12S
- CN SX Eagle
- ZZYZX X Vert 29" I Front
- ZZYZX X Vert 650B I Rear
- Schwalbe Smart Sam 60-622 I Front
- Schwalbe Smart Sam 70-584 I Rear
- Selle Italia X3 XP BOOST Superfl ow
- ZZYZX Suspension Seatpost 30.9mm
- ZZYZX SL Alloy Stem
- ZZYZX SL Alloy Handlebar
- ZZYZX SL Alloy Handlebar

FARBE COLOR

Race Orange | Gray Silver

BK29406

RAHMEN FRAME

E-POWER X VERT SPORT | SHADOW EDGE TUBE 3.0

FEATURES

39 | 44 | 49 | 54

UVP RRP **3.799 EUR**

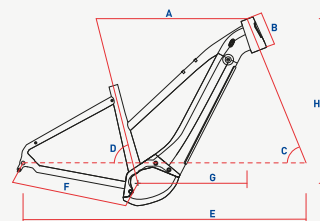

CM	A	B	C	D	E	F	G	H
39	617	150	66	73	1194	455	410	677
44	632	150	66	73	1209	455	425	677
49	650	160	66	73	1228	455	440	686
54	667	170	66	73	1247	455	455	695



Das Rendering dient nur als Referenz
The Rendering is for Reference only

E-POWER X-VERT RACE GENT

Komfort und Grip dank Wheel Split – vorne 29 Zoll Reifen und hinten 650B+. Wheel Split – Front 29 inch and Rear 650B+ tyres offer comfort and grip.

Shadow Edge Tube 3.0 – 750 Wh Bosch Akku elegant verpackt im Unterrohr. Shadow Edge Tube 3.0 - 750 Wh Bosch battery elegantly integrated in the down tube.

Trail Hardtail mit 120mm Federweg und sportlichem Gent-Rahmen. Trail hardtail with 120mm travel and sporty Gents frame.

625
Wh



- Bosch CX Cruise BES3
- Bosch PowerTube 625 Wh
- Bosch Purion 200 Display
- E-Power X Vert Gent
- SR Suntour XCM32 Boost LOR 29" 120 mm
- Sram SX Eagle
- Sram SX Eagle
- Tektro HD-M275 180 mm
- Tektro HD-M275 180 mm
- Sram X-SYNC 2 34T
- Sram PG1210 Eagle 11-50T
- CN SX EAGLE
- ZZYX 29" I Front
- ZZYX 650B I Rear
- Schwalbe Smart Sam 29" x 2,35" I Front
- Schwalbe Smart Sam 650B x 2,8" I Rear
- SELLE ITALIA; X3 XP BOOST Superfl ow
- ZZYX Alloy Seatpost 30,9 x 350mm
- ZZYX SL Alloy Stem
- ZZYX Mountain Handlebar 760 mm wide

FARBE COLOR

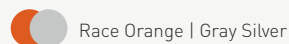

BK29407

RAHMEN FRAME

E-POWER X VERT GENT | SHADOW EDGE TUBE 3.0

FEATURES

44 | 49 | 54 | 57

UVP RRP **3.799 EUR**

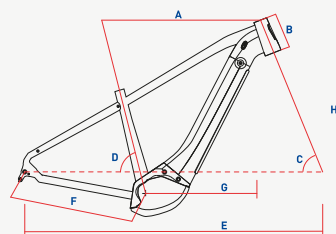

CM	A	B	C	D	E	F	G	H
44	617	150	66	73	1194	455	410	677
49	632	150	66	73	1209	455	425	677
54	650	160	66	73	1228	455	440	686
57	667	170	66	73	1247	455	455	695



Das Rendering dient nur als Referenz
The Rendering is for Reference only

E-POWER X VERT ROCK 26

Mit seinen 26 Zoll Reifen und einer kompakten Rahmengeometrie eignet sich das X Vert perfekt für Rookies und den E-MTB Nachwuchs. The X Vert Young series a 26 inch e-bike for the rookies and MTB stars of tomorrow.

Die hier verbaute Bosch Antriebseinheit unterstützt den jungen Fahrer bei langen Touren mit der Familie. Bosch drive system helps the young riders on long day trips with the whole family.



- Bosch Active Line Plus (25km/h)
- Bosch Power Pack 400 Frame
- Bosch Purion
- E-Power X Vert Rock
- SR Suntour XCR-AIR LOR DS 26" 100 mm
- Shimano Altus SGS 9S
- Shimano Altus 9S
- Tektro HDM-282 160mm I Front
- Tektro HDM-282 160mm I Rear
- ZZYZX E-Power Crank 34T
- Shimano HG200 11-36T 9S
- KMC X9 9S
- ZZYZX X Vert 26" I Front
- ZZYZX X Vert 26" I Rear
- Innova Podium 26" x 2.25 I Front
- Innova Podium 26" x 2.25 I Rear
- corratec sport saddle
- ZZYZX Suspension Seatpost 30.9mm
- ZZYZX SL Alloy Stem
- ZZYZX SL Alloy Handlebar
- ZZYZX SL Alloy Handlebar

FARBE COLOR

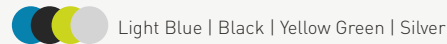

BK29408

RAHMEN FRAME

E-POWER X VERT

FEATURES

39

VVP RRP 2.699 EUR

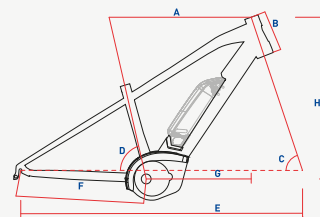

CM	A	B	C	D	E	F	G	H
39	616	150	66	73	1194	455	410	676
44	631	160	66	73	1209	455	425	676
49	649	160	66	73	1228	455	440	685
54	667	170	66	73	1247	455	455	694

Das Rendering dient nur als Referenz
The Rendering is for Reference only























E-POWER X-VERT EL PRO

Leichtes Trail Hardtail mit 130 mm Federweg und flacheren Lenkwinkel - für alle, die E-Power und wahre Muskelkraft kombinieren möchten. Lightweight trail hardtail with 130 mm travel and flatter steering angle - for all those who want to combine e-power and real muscle power.

Bosch PL SX 400 Wh Motor kann je nach Bedarf durch On/Off-Schalter am Oberrohr dosiert zugeschaltet werden. Bosch PL SX 400 Wh motor can be switched on and off as needed via an on/off switch on the top tube.

Vereint Sportlichkeit, Leichtigkeit und Dynamik mit Reichweite und E-Power. Combines sportiness, effortlessness and dynamics with range and e-power.

-  Bosch Performance Line SX
-  Bosch Compact Tube 400 Wh + Range Extender Ready
-  Bosch Purion 200 Display
-  E-Power X-Vert EL Pro
-  RockShox Pike Select Charger RC 29" Boost 130 mm
-  Rockshox Deluxe Select+
-  Sram GX Eagle
-  Sram GX Eagle
-  Sram Level Bronze Stealth 4-Piston 203 mm
-  Sram Level Bronze Stealth 4-Piston 180 mm
-  Sram X-SYNC 2 34T chainring
-  Sram XG-1275 Eagle 10-52T
-  CN SX Eagle
-  Mavic Crossmax XL 29" XD | Front
-  Mavic Crossmax XL 29" XD | Rear
-  Schwalbe Nobby Nic 29" x 2,25" | Front
-  Schwalbe Nobby Nic 29" x 2,25" | Rear
-  Selle Italia; X3 XP Boost Superflow
-  Kindshock RAGEi Seatpost 30,9 x 125/150 mm
-  ZZYZX SL Alloy Stem
-  ZZYZX Alloy Handlebar 760 mm wide

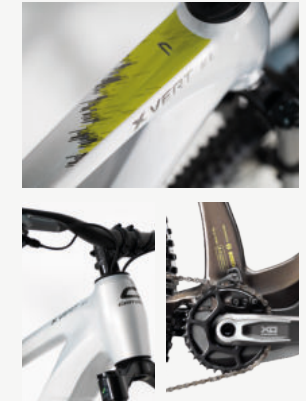

FARBE COLOR



Brown | Silver | Green

BK29415

 44 | 49 | 54 | 57

UVP RRP **5.499 EUR**

RAHMEN FRAME

E-POWER X-VERT EL

CM	A	B	C	D	E	F	G	H
44	638	145	66	73	1212	455	430	672
49	649	145	66	73	1227	455	445	672
54	667	150	66	73	1244	455	460	677
57	685	160	66	73	1263	455	475	686

FEATURES























Bilder dienen nur als Veranschaulichung
Images are for illustrative purposes only

E-GRAVEL EL

Vielseitiges E-Gravel mit flacheren Lenkwinkel - für alle, die E-Power und wahre Muskelkraft auf Bike-Packing-Touren kombinieren möchten. Multipurpose e-gravel bike with flatter steering angle - for all those who want to combine e-power and real muscle power on bikepacking tours.

Bosch PL SX 400 Wh Motor kann je nach Bedarf durch On/Off-Schalter am Oberrohr dosiert zugeschaltet werden. Bosch PL SX 400 Wh motor can be switched on and off as required by an on/off switch on the top tube.

Vereint Sportlichkeit, Leichtigkeit und Dynamik mit Reichweite und E-Power. Combines sportiness, effortlessness and dynamics with range and epower.

-  Bosch Performance Line SX
-  Bosch Compact Tube 400 Wh + Range Extender Ready
-  Bosch Kiox 200 Display + mini remote
-  E-Gravel EL
-  TBD
-  SR Suntour EDGE R
-  Sram Apex Eagle D1
-  Sram Apex 1x12s
-  Sram Apex 160 mm
-  Sram Apex 160 mm
-  Sram Eagle 38T chainring
-  Sram XG 1275 Eagle 10-50T
-  CN SX EAGLE
-  Mavic Allroad S I Front
-  Mavic Allroad S I Rear
-  SCHWALBE G-ONE BITE Perf, 28"x 2" I Front
-  SCHWALBE G-ONE BITE Perf, 28"x 2" I Rear
-  Selle Italia; X3 XP Boost Superflow
-  ZZZZX Alloy Seatpost 30,9 x 350mm
-  ZZZZX SL Alloy Stem
-  ZZZZX Alloy Handlebar



GRAVEL EL

FARBE COLOR

 Metallic Dark Red | Night Black | Cool Grey

BK29424

RAHMEN FRAME

E-POWER X-VERT EL

FEATURES

 29 | 44 | 49 | 54 | 57

UVP RRP **4.999 EUR**

CM	A	B	C	D	E	F	G	H
39	570	145	71	74	1123	460	440	582
44	580	160	71	74	1128	460	440	594
49	589	175	71	73	1130	460	440	608
54	598	190	71	73	1138	460	440	622
57	606	210	71	72	1147	460	440	641



Bilder dienen nur als Veranschaulichung
Images are for illustrative purposes only



THE MOUNTAIN CROSS E-BIKE

Mountain Cross Bikes, auch als „MTC“ bezeichnet, nehmen bei corratec einen immer höheren Stellenwert ein, da sie in jedem Gelände perfekt eingesetzt werden können. Die verbaute Shadow Edge 3.0 Technologie in Verbindung mit dem integrierten Akku sorgen für eine formschöne Optik und verleiht dem Rad die höchstmögliche Steifigkeit. Hochwertige Komponenten wie der Direct Mount Gepäckträger mit integriertem Rücklicht unterstützen den Fahrer bei langen Mehrtagestouren.

„MTC“ stands for “Mountain Cross Bike”, the right bike for every terrain. This includes the direct mount luggage rack with the stylishly integrated tail light, which offers support on long multi-day rides . The “Shadow Edge Tube 3.0” technology gives the bike a stable and secure frame and the integrated rechargeable battery gives it a clean look. The bike is also equipped with quality Shimano, SR Suntour, Schwalbe and Selle Italia components.







**BESTES
E-BIKE DESIGN**

KATEGORIE: SUV/CROSS

2023

www.focus-mobility.de

Zwei weitere Modelle erhielten
diese Auszeichnung

E-POWER MTC 120



3.0

SHADOW
EDGE TUBE

120

 mm

Rockshox Lyrik Federweg
Rockshox Lyrik travel

ICR

Komplett innenverlegte
Kabelführung
Internal cable routing



MAXIMALE SICHERHEIT MAXIMUM SAFETY

Das neuentwickelte Shadow Edge Tube 3.0 - Der weltweit stabilste und sicherste corrated E-Bike Rahmen geht in die nächste Runde. Ein einzigartiges neues Wabendesign sorgt für eine erstklassige Optik.

The newly developed Shadow Edge Tube 3.0 - the world's most stable and safest corrated e-bike frame goes into the next round. An unique new honeycomb design ensures a first-class look.

MOUNTAINCROSS BIKE

Vollausgestattetes Fully für jeden Einsatzbereich & unterschiedliches Gelände.
Maximale Traktion und Dämpfung auf langen Trekkingtouren.

Fully equipped for every application and different terrain.
Maximum traction and damping on long trekking tours.



ABSOLUT BELASTBAR ABSOLUTELY RESILIENT

Direct Mount Gepäckträger ohne zusätzliche Streben bis 25Kg belastbar. Das voll integrierte Rücklicht sorgt für eine cleane Optik. Extrem stabil, sicher und schön zugleich.

Direct mount luggage rack can be loaded up to 25kg. The fully integrated rear light ensures a clean look. Extremely stable, safe and beautiful at the same time.

E-POWER MTC 120 PRO

Das Mountain Cross Bike (MTC) – Für jedes Gelände das perfekte Bike. The brand new Mountain Cross Bike (MTC) – The perfect bike for every terrain.

Direct Mount Gepäckträger bis 25kg belastbar mit integriertem Rücklicht. Direct Mount luggage rack holds loads up to 25 kg with integrated rear light.

Shadow Edge Tube 3.0 – 750 Wh Bosch Akku elegant verpackt im Unterrohr. Shadow Edge Tube 3.0 – 750 Wh Bosch battery elegantly integrated in the down tube.

750

Wh



- Bosch CX Cruise BES3
- Bosch PowerTube 750 Wh
- Bosch Kiox 300 Display
- E-Power MTC 120
- Rockshox 35 SILVER TK 29" 130 mm
- Rockshox Deluxe Select+
- SRAM GX Eagle
- SRAM GX Eagle
- SRAM Guide T 4 piston 203 mm
- SRAM Guide T 4 piston 203 mm
- SRAM X-SYNC 2 34T chainring
- SRAM PG1210 Eagle 11-50T
- CN SX Eagle
- ZZYZX 29" I Front
- ZZYZX 29" I Rear
- Schwalbe Johnny Watts 60-622 I Front
- Schwalbe Johnny Watts 60-622 I Rear
- Selle Royal Essenza Moderate
- Kindshock RAGEi Seatpost 30,9 x 125/150 mm
- ZZYZX SL Alloy Stem
- ZZYZX Alloy Handlebar 760 mm wide

FARBE COLOR

Silver | Anodized White | Red

BK29430

RAHMEN FRAME

E-POWER MTC 120 | SHADOW EDGE TUBE 3.0

FEATURES

39 | 44 | 49 | 54

UVP RRP **5.899 EUR**

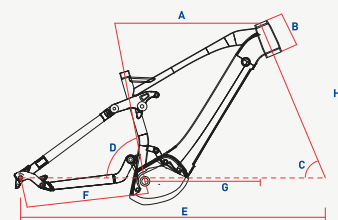

CM	A	B	C	D	E	F	G	H
39	613	155	67	74	1213	468	430	638
44	633	155	67	74	1233	468	450	638
49	654	160	67	74	1255	468	470	642
54	677	170	67	74	1279	468	490	651



Bilder dienen nur als Veranschaulichung
Images are for illustrative purposes only

E-POWER MTC 120 ELITE

Das Mountain Cross Bike (MTC) – Für jedes Gelände das perfekte Bike. The brandnew Mountain Cross Bike (MTC) – The perfect bike for every terrain.

Direct Mount Gepäckträger bis 25kg belastbar mit integriertem Rücklicht. Rear light integrated in the luggage rack – Smart integration for a clean look.

Shadow Edge Tube 3.0 – weltweit stabilster und sicherster corrated E-Bike Rahmen. Shadow Edge Tube 3.0 – worldwide most stable and safest corrated E-Bike Frame.

750 Wh



- Bosch Performance CX Cruise BES3 (25 km/h)
- Bosch Power Tube 750Wh
- Bosch Kiox 300
- E-Power MTC 120
- SR Suntour XCR32-Boost-AIR LOR DS 29" 120mm
- SR Suntour EDGE R 190 x 45 mm Air
- Sram SX Eagle 12S
- Sram SX Eagle 12S
- Tektro HD-M275 180mm I Front
- Tektro HD-M275 180mm I Rear
- Sram X-Sync 34T
- Sram PG1210 Eagle 11-50T 12S
- Sram SX Eagle 12S
- ZZYZX Cross Attack 29" I Front
- ZZYZX Cross Attack 29" I Rear
- Schwalbe Johnny Watts 60-622 I Front
- Schwalbe Johnny Watts 60-622 I Rear
- Selle Royal Essenza Moderate
- Kindshock RAGEi Seatpost 30,9 x 125/150 mm
- ZZYZX SL Alloy Stem
- ZZYZX SL Alloy Handlebar

FARBE COLOR

Metallic Gray Blue | Wine Red | Light Blue

BK29431

RAHMEN FRAME

E-POWER MTC 120 | SHADOW EDGE TUBE 3.0

FEATURES

39 | 44 | 49 | 54

UVP RRP 5.499 EUR

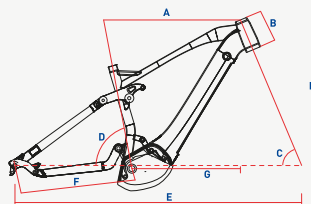

CM	A	B	C	D	E	F	G	H
39	613	155	67	74	1213	468	430	638
44	633	155	67	74	1233	468	450	638
49	654	160	67	74	1255	468	470	642
54	677	170	67	74	1279	468	490	651



Bilder dienen nur als Veranschaulichung
Images are for illustrative purposes only

E-POWER MTC 120

Das Mountain Cross Bike (MTC) – Für jedes Gelände das perfekte Bike. The brandnew Mountain Cross Bike (MTC) – The perfect bike for every terrain.

Im Gepäckträger integriertes Rücklicht für eine saubere Optik. Rear light integrated in the luggage rack – Smart integration for a clean look.

Shadow Edge Tube 3.0 – weltweit stabilster und sicherster corrated E-Bike Rahmen. Shadow Edge Tube 3.0 – worldwide most stable and safest corrated E-Bike Frame.

625

Wh



- Bosch Performance CX Cruise BES3 (25 km/h)
- Bosch Power Tube 625Wh
- Bosch Intuvia 100
- E-Power MTC 120
- SR Suntour XCR32-Boost-AIR LOR DS 29" 120 mm
- SR Suntour EDGE R 190 x 45 mm Air
- Sram SX Eagle 12S
- Sram SX Eagle 12S
- Tektro HDM-275 180mm I Front
- Tektro HDM-275 180mm I Rear
- Sram X-Sync 34T
- Sram PG1210 Eagle 11-50T 12S
- Sram SX Eagle 12S
- ZZYZX Cross Attack 29" I Front
- ZZYZX Cross Attack 29" I Rear
- Schwalbe Johnny Watts 60-622 I Front
- Schwalbe Johnny Watts 60-622 I Rear
- Selle Royal Essenza Moderate
- Kindshock RAGEi Seatpost 30,9 x 125/150 mm
- ZZYZX SL Alloy Stem
- ZZYZX SL Alloy Handlebar

FARBE COLOR



Gray Green | Silver | Pearlized Black

BK29432

RAHMEN FRAME

E-POWER MTC 120 | SHADOW EDGE TUBE 3.0

FEATURES

39 | 44 | 49 | 54

UVP RRP **4.899 EUR**

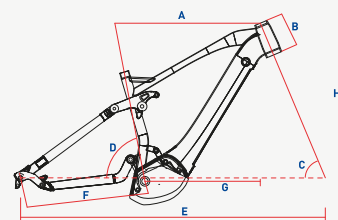

CM	A	B	C	D	E	F	G	H
39	613	155	67	74	1213	468	430	638
44	633	155	67	74	1233	468	450	638
49	654	160	67	74	1255	468	470	642
54	677	170	67	74	1279	468	490	651



Das Rendering dient nur als Referenz
The Rendering is for Reference only



E-POWER MTC 100 WAVE 7

Neuer Rahmen für maximale Sicherheit und bestes Fahrgefühl auf und abseits der Straße. New frame for maximum safety and the best riding experience on- and off-road.

Das ideale E-Bike als SUV-Fully mit den besten Dämpfungseigenschaften für jedes Terrain. The ideal e-bike as an SUV fully with the best damping properties for any terrain.

Hochwertige Komponenten wie der direkt montierbare Gepäckträger mit integriertem Rücklicht. High quality components such as the direct mount luggage rack with integrated rear light.

750 Wh



- Bosch CX Cruise BES3
- Bosch PowerTube 750 Wh
- Bosch Kiox 300 Display
- E-Power MTC 100 Wave
- SR Suntour MOBIE25 Coil 27.5" 100mm
- SR Suntour EDGE R
- SRAM SX Eagle
- SRAM SX Eagle
- TEKTRO HD M535 4 piston 203 mm
- TEKTRO HD M535 4 piston 180 mm
- ZZYZX E-Power Crank 34T
- SRAM PG1210 Eagle 11-50T
- CN SX Eagle
- ZZYZX 29" I Front
- ZZYZX 29" I Rear
- Schwalbe Johnny Watts 29" I Front
- Schwalbe Johnny Watts 29" I Rear
- Selle Royal Essenza Moderate
- Kindshock RAGEi 30.9mm
- ZZYZX SL Alloy Stem
- ZZYZX Alloy Handlebar 760 mm wide

FARBE COLOR



Anodized White | Light Copper | Light Silver | Dark Metallic Gray

BK29433

RAHMEN FRAME

E-POWER MTC WAVE

FEATURES

44 | 49 | 54

UVP RRP 5.299 EUR

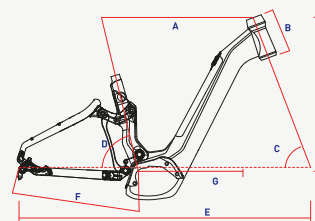

CM	A	B	C	D	E	F	G	H
44	606	150	67	74	1246	490	445	639
49	620	160	67	74	1261	490	456	648
54	633	170	67	74	1276	490	467	658



Bilder dienen nur als Veranschaulichung
Images are for illustrative purposes only

E-POWER MTC 100 WAVE 6

Neuer Rahmen für maximale Sicherheit und bestes Fahrgefühl auf und abseits der Straße. New frame for maximum safety and the best riding experience on- and off-road.

Das ideale E-Bike als SUV-Fully mit den besten Dämpfungseigenschaften für jedes Terrain. The ideal e-bike as an SUV fully with the best damping properties for any terrain.

Hochwertige Komponenten wie der direkt montierbare Gepäckträger mit integriertem Rücklicht. High quality components such as the direct mount luggage rack with integrated rear light.

625_{Wh}



- Bosch CX Cruise BES3
- Bosch PowerTube 625 Wh
- Bosch Intuvia 100 Display
- E-Power MTC 100 Wave
- SR Suntour MOBIE25 Coil 27.5" 100mm
- SR Suntour EDGE R
- SRAM SX Eagle
- SRAM SX Eagle
- TEKTRO HD M535 4 piston 203 mm
- TEKTRO HD M535 4 piston 180 mm
- ZZYZX E-Power Crank 34T
- SRAM PG1210 Eagle 11-50T
- CN SX Eagle
- ZZYZX 29" | Front
- ZZYZX 29" | Rear
- Schwalbe Johnny Watts 29" | Front
- Schwalbe Johnny Watts 29" | Rear
- Selle Royal Essenza Moderate
- Kindshock RAGEi 30.9mm
- ZZYZX SL Alloy Stem
- ZZYZX Alloy Handlebar 760 mm wide

FARBE COLOR



Metallic Gray Blue | Wine Red | Light Blue

BK29434

RAHMEN FRAME

E-POWER MTC WAVE

FEATURES

39 | 44 | 49 | 54

UVP RRP 4.999 EUR

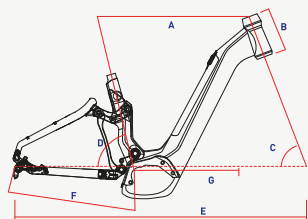

CM	A	B	C	D	E	F	G	H
44	606	150	67	74	1246	490	445	639
49	620	160	67	74	1261	490	456	648
54	633	170	67	74	1276	490	467	658

Das Rendering dient nur als Referenz
The Rendering is for Reference only

E-POWER MTC 12S SE 3.0 SPORT

Das Mountain Cross Bike (MTC) – Für jedes Gelände das perfekte Bike. The brandnew Mountain Cross Bike (MTC) – The perfect bike for every terrain.

Direct Mount Gepäckträger bis 25kg belastbar mit integriertem Rücklicht. Rear light integrated in the luggage rack – Smart integration for a clean look.

Shadow Edge Tube 3.0 – 750 Wh Bosch Akku elegant verpackt im Unterrohr. Shadow Edge Tube 3.0 – worldwide most stable and safest corrated E-Bike Frame.

750

Wh



- Bosch Performance CX Cruise BES3 (25 km/h)
- Bosch Power Tube 750Wh
- Bosch Intuvia 100
- E-Power MTC Trapez
- SR Suntour XCM LO DS 29" 80mm
- Sram SX Eagle 12S
- Sram SX Eagle 12S
- Tektro HD-T275 180mm | Front
- Tektro HD-T275 160mm | Rear
- Sram X-Sync 38T
- Sram PG1210 Eagle 11-50T 12S
- Sram SX Eagle 12S
- ZZZZX MTC Cross 29" | Front
- ZZZZX MTC Cross 29" | Rear
- Schwalbe Smart Sam 57-622 | Front
- Schwalbe Smart Sam 57-622 | Rear
- corratec sport saddle
- ZZZZX Suspension Seatpost 30.9mm
- ZZZZX SL Alloy Stem
- ZZZZX SL Alloy Handlebar
- ZZZZX SL Alloy Handlebar

FARBE COLOR



Metallic Brown | Pearlized Black | Orange | Silver

BK29440

RAHMEN FRAME

E-POWER MTC SPORT | SHADOW EDGE TUBE 3.0

FEATURES

39 | 44 | 49 | 54

UVP RRP 4.099 EUR

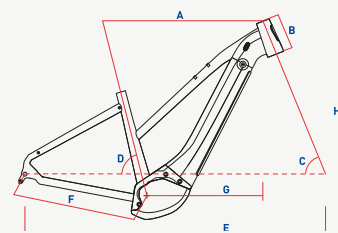

CM	A	B	C	D	E	F	G	H
39	631	170	68	74	1193	460	440	664
44	639	170	68	74	1201	460	448	664
49	649	180	68	74	1212	460	456	674
54	647	190	68	75	1224	460	464	683



Das Rendering dient nur als Referenz
The Rendering is for Reference only

E-POWER MTC ELITE 12S SE 3.0 GENT

Das Mountain Cross Bike (MTC) – Für jedes Gelände das perfekte Bike. The brandnew Mountain Cross Bike (MTC) – The perfect bike for every terrain.

Direct Mount Gepäckträger bis 25kg belastbar mit integriertem Rücklicht. Rear light integrated in the luggage rack – Smart integration for a clean look.

Shadow Edge Tube 3.0 – weltweit stabilster und sicherster corrated E-Bike Rahmen. Shadow Edge Tube 3.0 – worldwide most stable and safest corrated E-Bike Frame.

750 Wh



- Bosch Performance CX Cruise BES3 (25 km/h)
- Bosch Power Tube 750Wh
- Bosch Intuvia 100
- E-Power MTC Gent
- SR Suntour XCM LO DS 29" 80mm
- Sram SX Eagle 12S
- Sram SX Eagle 12S
- Tektro HD-T275 180mm | Front
- Tektro HD-T275 160mm | Rear
- Sram X-Sync 38T
- Sram PG1210 Eagle 11-50T 12S
- Sram SX Eagle 12S
- ZYZX MTC Cross 29" | Front
- ZYZX MTC Cross 29" | Rear
- Schwalbe Smart Sam 57-622 | Front
- Schwalbe Smart Sam 57-622 | Rear
- Selle Royal Essenza Moderate
- ZYZX Suspension Seatpost 30.9mm
- ZYZX SL Alloy Stem
- ZYZX SL Alloy Handlebar

FARBE COLOR



Metallic Brown | Pearlized Black | Orange | Silver

BK29441

RAHMEN FRAME

E-POWER MTC GENT | SHADOW EDGE TUBE 3.0

FEATURES

39 | 44 | 49 | 54

UVP RRP 4.099 EUR

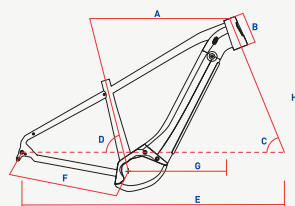

CM	A	B	C	D	E	F	G	H
39	631	170	68	74	1193	460	440	664
44	639	170	68	74	1201	460	448	664
49	649	180	68	74	1212	460	456	674
54	647	190	68	75	1224	460	464	683



Das Rendering dient nur als Referenz
The Rendering is for Reference only

E-POWER MTC 12S SPORT

Das Mountain Cross Bike (MTC) – Für jedes Gelände das perfekte Bike. The brandnew Mountain Cross Bike (MTC) – The perfect bike for every terrain.

Direct Mount Gepäckträger bis 25kg belastbar mit integriertem Rücklicht. Direct Mount luggage rack holds up to 25 kg load with integrated rear light.

Shadow Edge Tube 3.0 – 625 Wh Bosch Akku elegant verpackt im Unterrohr. Shadow Edge Tube 3.0 – 625 Wh Bosch battery elegantly integrated into the down tube.

625

Wh



- Bosch CX Cruise BES3
- Bosch PowerTube 625 Wh
- Bosch Intuvia 100 Display
- E-Power MTC Sport
- SR Suntour XCM32 ATB DS LO 29" 100mm
- Sram SX Eagle
- Sram SX Eagle
- TEKTRO HD-M275 180 mm
- TEKTRO HD-M275 180 mm
- Sram X-Sync 38T
- Sram PG1210 Eagle 11-50T
- CN SX EAGLE
- ZZYZX 29" I Front
- ZZYZX 29" I Rear
- Schwalbe Smart Sam 29x2.25" I Front
- Schwalbe Smart Sam 29*2.25" I Rear
- Selle Royal Essenza Moderate
- ZZYZX Alloy Seatpost 30,9 x 350mm
- ZZYZX SL Alloy Stem
- ZZYZX Alloy Handlebar 720 mm wide

FARBE COLOR



Light Blue Silver | Orange | Brilliant Petrol

BK29442

RAHMEN FRAME

E-POWER MTC SPORT | SHADOW EDGE TUBE 3.0

FEATURES

39 | 44 | 49 | 54

VVP RRP **3.899 EUR**

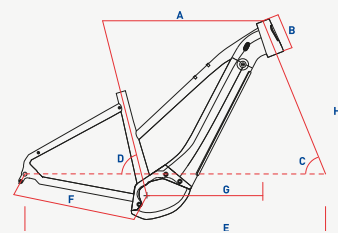

CM	A	B	C	D	E	F	G	H
39	631	170	68	74	1193	460	440	664
44	639	170	68	74	1201	460	448	664
49	649	180	68	74	1212	460	456	674
54	647	190	68	75	1224	460	464	683



Bilder dienen nur als Veranschaulichung
Images are for illustrative purposes only

E-POWER MTC 12S GENT

Das Mountain Cross Bike (MTC) – Für jedes Gelände das perfekte Bike. The brandnew Mountain Cross Bike (MTC) – The perfect bike for every terrain.

Direct Mount Gepäckträger bis 25kg belastbar mit integriertem Rücklicht. Rear light integrated in the luggage rack – Smart integration for a clean look.

Shadow Edge Tube 3.0 – weltweit stabilster und sicherster corrated E-Bike Rahmen. Shadow Edge Tube 3.0 – worldwide most stable and safest corrated E-Bike Frame.



625 Wh



- Bosch CX Cruise BES3
- Bosch PowerTube 625 Wh
- Bosch Intuvia 100 Display
- E-Power MTC Gent
- SR Suntour XCM32 ATB DS LO 29" 100mm
- Sram SX Eagle
- Sram SX Eagle
- TEKTRO HD-M275 180 mm
- TEKTRO HD-M275 180 mm
- Sram X-Sync 38T
- Sram PG1210 Eagle 11-50T
- CN SX EAGLE
- ZYZX 29" I Front
- ZYZX 29" I Rear
- Schwalbe Smart Sam 29x2.25" I Front
- Schwalbe Smart Sam 29x2.25" I Rear
- Selle Royal Essenza Moderate
- ZYZX Alloy Seatpost 30,9 x 350mm
- ZYZX SL Alloy Stem
- ZYZX Alloy Handlebar 720 mm

FARBE COLOR

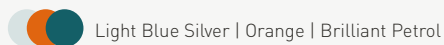

BK29443

RAHMEN FRAME

E-POWER MTC GENT | SHADOW EDGE TUBE 3.0

FEATURES

44 | 49 | 54 | 57

UVP RRP 3.899 EUR

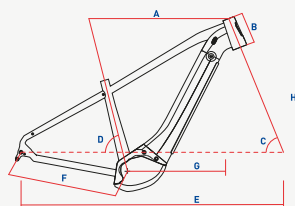

CM	A	B	C	D	E	F	G	H
44	636	165	68	74	1197	460	447	660
49	644	165	68	74	1205	460	455	660
54	653	170	68	74	1213	460	463	664
57	651	180	68	75	1227	460	471	674



Bilder dienen nur als Veranschaulichung
Images are for illustrative purposes only

corrateg

LifeS

Let's go crazy – mit unserem neuen corrateg LifeS sind Dir alle Blicke garantiert! Die extravagante Rahmenform und der moderne Style des urbanen corrateg E-Bikes sind einzigartig am Markt. Mit der Wahl von Farbkombinationen des Rahmens und Schutzblech kannst Du Dir Dein stylisches Rad selbst nach Deinen Wünschen gestalten, um trendig durch die City zu cruisen. Die hervorragende Geometrie des Rahmens und die breiten Reifen garantieren Dir zusätzlich höchste Sicherheit. Beide Füße können jederzeit, auch während der Fahrt, auf dem Boden abgestellt werden.

Discover a different world of corrateg. Cheeky, provocative, hip, stylish, modern, outstanding, cool, unique - that is what corrateg Life S stands for. The extravagant frame design and the modern style of the urban corrateg e-bike are unique. Customise your LifeS by choosing the colour of your frame and your mud guards, to your personal taste. Cruise through the city easily on your compact Life S. Its special geometry and wide tyres enable you to touch the ground with both feet even whilst riding.

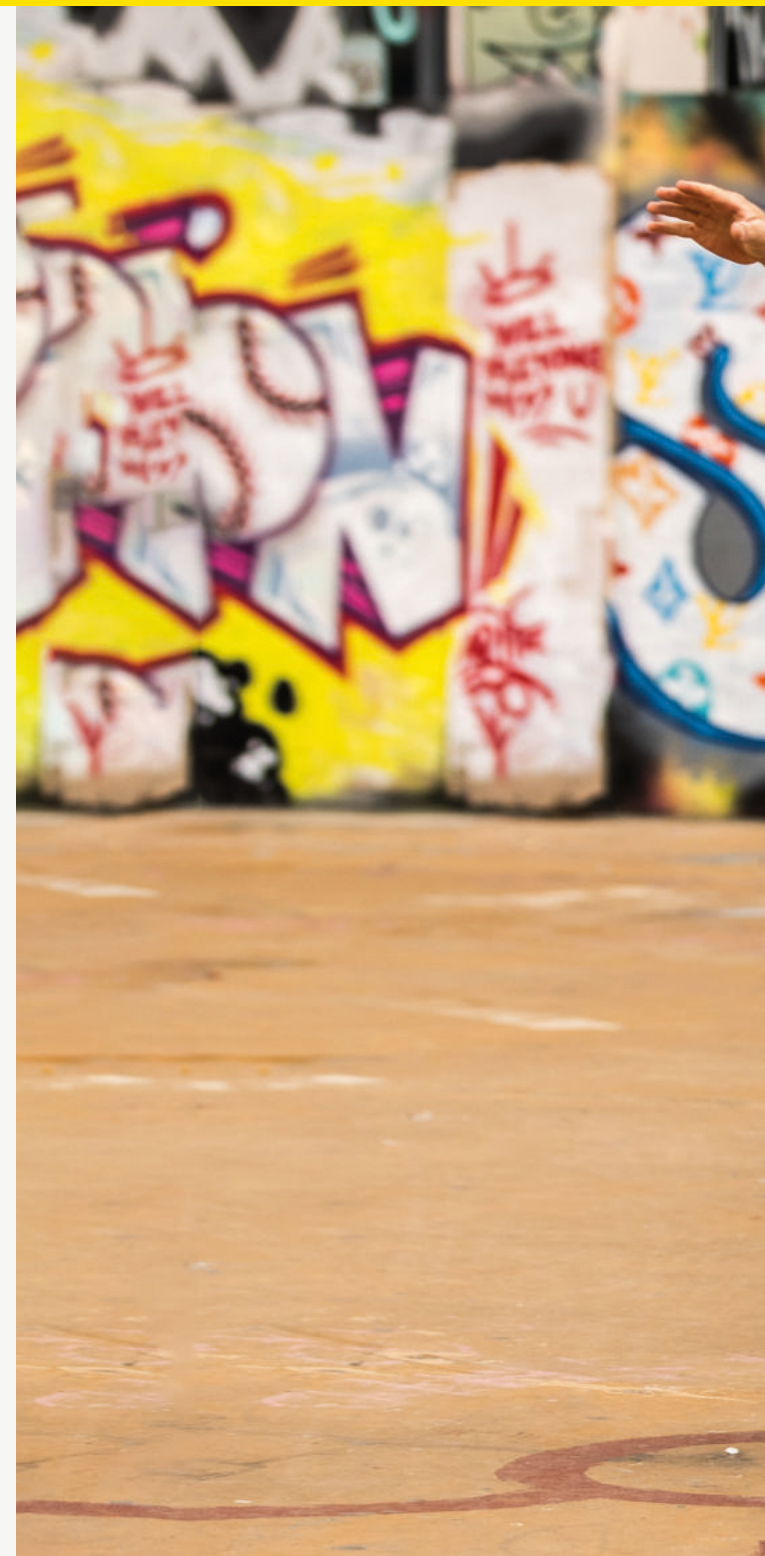



LifeS

corrateg



BREITE REIFEN

WIDE TIRES

Konzipiert für Kopfsteinpflaster und Straßenbahnschienen.
Developed for cobblestones and tram tracks.



TIEFER EINSTIEG

LOW ENTRY

Komfortabler und tiefer Einstieg um problemlos auf- und abzusteigen.
Comfortable and low entry to get on and off the bike quickly.



GEPÄCKTRÄGER

STURDY CARRIER

Extra großer und stabiler Gepäckträger für die täglichen Einkäufe.
Extra large and stable carrier system for the daily needs.



BREITER LENKER

WIDE HANDLEBAR

Sorgt für zusätzliche Sicherheit und ein ergonomisches Fahrgefühl.
Provides additional safety and an ergonomic feeling.



KOMFORT SATTEL

COMFORT SADDLE

Ermüdungsfreies und komfortables Sitzen.
Relaxed and comfortable sitting.



KRAFTVOLLER MOTOR

POWERFUL ENGINE

Bosch Motor unterstützt bis 25 km/h und entkoppelt vollständig.
Powerfull Bosch engine supports up to 25 km/h.



ONE SIZE FITS ALL

ONE SIZE FITS ALL

Eine Rahmengröße für jede Körpergröße und jeden Typen.
One frame fits (almost) for every body size.





CORRATEC LIFE S P5

One Size Fits All – Eine Rahmengröße für jeden Fahrertyp. One Size Fits All – One frame size for every type of rider.

Individuelle Zusammenstellung der Schutzblech-farbkombinationen. Customized mud guards combination for an individual design.

Extra breite Reifen für mehr Fahrsicherheit in der Stadt. Extra wide tires for superior safety and comfort in the city.



Bilder dienen nur als Veranschaulichung
Images are for illustrative purposes only

- Bosch Active Line Plus (25km/h)
- Bosch Power Pack 500Wh Frame
- Bosch Purion
- corratec Life S
- Life S Alloy Fork Boost
- Shimano Nexus 8S
- Shimano Nexus Revo Shifter 8S
- Shimano MT200 180mm I Front
- Shimano MT200 160mm I Rear
- ZYZX E-Power Crank 38T
- Shimano 16T
- KMC Z1 8S
- ZYZX 20" I Front
- ZYZX 20" I Rear
- Inova 20" x 3.0 I Front
- Inova 20" x 3.0 I Rear
- corratec comfort saddle
- ZYZX Suspension Seatpost 30.9mm
- Ergotec Cobra Tube Level 2
- Ergotec Bügel EWG

FARBE COLOR



BK29361

RAHMEN FRAME

CORRATEC LIFE S

FEATURES

UNI

UVP RRP 3.499 EUR

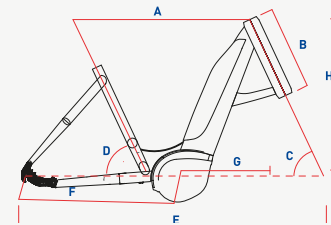

CM	A	B	C	D	E	F	G	H
UNI	627	300	65	64	1130	541	259	568



CORRATEC LIFE S CROSS P5

One Size Fits All – Eine Rahmengröße für jeden Fahrertyp. One Size Fits All – One frame size for every type of rider.

Individuelle Zusammenstellung der Schutzblech-farbkombinationen. Customized mud guards combination for an individual design.

Extra breite Reifen für mehr Fahrsicherheit in der Stadt. Extra wide tires for superior safety and comfort in the city.



- Bosch Performance Line GEN3
- Bosch PowerPack 545 Wh
- Bosch Purion 200
- Corratec Life S
- Corratec Life S Fork
- Shimano Cues GS 9S
- Shimano Cues 9S
- SHIMANO, MT200 180mm
- SHIMANO, MT200 160mm
- ZYZX E-Power Crank 38T
- Shimano Cues 9S 11-36T
- KMC eGlide
- ZYZX 20" | Front
- ZYZX 20" | Rear
- KENDA CROSSER 20*4.0 | Front
- KENDA CROSSER 20*4.0 | Rear
- ZYZX Comfort Saddle
- ZYZX Alloy Seatpost 30,9 x 350mm
- Ergotec Cobra Tube Level 2
- Ergotec Handlebar

FARBE COLOR



BK29362

RAHMEN FRAME

CORRATEC LIFE S

FEATURES

UNI

UVP RRP 3.599 EUR

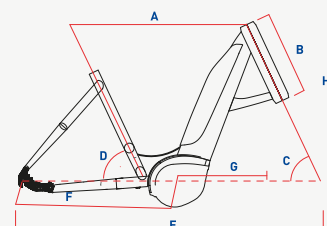

CM	A	B	C	D	E	F	G	H
UNI	627	300	65	64	1130	541	259	568



Bilder dienen nur als Veranschaulichung
Images are for illustrative purposes only



CORRATEC LIFE S DUAL P5

Perfekt für den urbanen Raum und für Menschen mit Dysfunktionen (Gleichgewichtsstörungen) geeignet. Perfect for urban areas and for people with dysfunctions (balance disorders).

Transportwunder mit Zuladegewicht vorne und hinten jeweils 25 kg. Transport miracle with a front and rear load weight of 25 kg each.

Parallel geführte Vorderreifen sorgen für maximale Stabilität und 545 Wh Bosch PowerPack. Parallel front tyres ensure maximum stability and 545 Wh Bosch battery.



Life S dual

- Bosch Performance Line GEN3
- Bosch PowerPack 545 Wh
- Bosch Purion 200
- Corratec Life S
- Corratec Life S Dual Fork
- Shimano Nexus 8s
- Shimano Nexus 8s
- TEKTRO HDT-745 4 Piston 203 mm
- TEKTRO HDT-740 4 Piston 203 mm
- ZYZX E-Power Crank 38T
- Shimano Nexus 16T 8s
- KMC Z1 Narrow EPT
- ZYZX 20" | Front
- ZYZX 20" | Rear
- Innova 20 x 3.0" | Front
- Innova 20 x 3.0" | Rear
- ZYZX Comfort Saddle
- ZYZX Alloy Seatpost 30,9 x 350mm
- Ergotec Cobra Tube Level 2
- Ergotec Handlebar

FARBE COLOR

Schwarz | Rot

BK29363

RAHMEN FRAME

CORRATEC LIFE S DUAL

FEATURES

UNI

UVP RRP **4.899 EUR**

CM	A	B	C	D	E	F	G	H
UNI	627	300	65	64	1130	541	259	568



Bilder dienen nur als Veranschaulichung
Images are for illustrative purposes only

CORRATEC LIFE S DUAL P7

Perfekt für den urbanen Raum und für Menschen mit Dysfunktionen (Gleichgewichtsstörungen) geeignet. Perfect for urban areas and for people with dysfunctions (balance disorders).

Transportwunder mit Zuladegewicht vorne und hinten jeweils 25 kg. Transport miracle with a front and rear load weight of 25 kg each.

Parallel geführte Vorderreifen sorgen für maximale Stabilität und 725 Wh Bosch PowerPack. Parallel front tyres ensure maximum stability and 75 Wh Bosch battery.



- Bosch Performance Line GEN3
- Bosch PowerPack 725 Wh
- Bosch Purion 200
- Corratec Life S
- corratec Life S Dual Fork
- Shimano Nexus 8s
- Shimano Nexus 8s
- TEKTRO HDT-745 4 Piston 203 mm
- TEKTRO HDT-740 4 Piston 203 mm
- ZZYX E-Power Crank 38T
- Shimano Nexus 16T 8s
- KMC Z1 Narrow EPT
- ZZYX 20" | Front
- ZZYX 20" | Rear
- Innova 20 x 3.0" | Front
- Innova 20 x 3.0" | Rear
- ZZYX Comfort Saddle
- ZZYX Alloy Seatpost 30,9 x 350mm
- Ergotec Cobra Tube Level 2
- Ergotec Handlebar

FARBE COLOR Schwarz | Rot

BK29364

RAHMEN FRAME

CORRATEC LIFE S DUAL

FEATURES

UNI

CM	A	B	C	D	E	F	G	H
UNI	627	300	65	64	1130	541	259	568

UVP RRP 5.199 EUR



Bilder dienen nur als Veranschaulichung
Images are for illustrative purposes only

corrateg LIFE

Das corrateg Life klassifiziert sich als SUV unter den E- Bikes. Durch die extrem stabile Bauweise mit dem Shadow Edge Tube 3.0 als weltweit sicherster corrateg E -Bike Rahmen, ist das Bike ideal für lange Touren. Eine Belastung bis 180kg Systemgewicht ist bei diesem Modell möglich. Der tiefe Einstieg und die ergonomischen Komponenten garantieren ein sehr angenehmes Gefühl beim Fahren auf Asphalt und auf Schotterpisten.

The corrateg Life is an SUV among the E-Bikes. With the world's most stable and safest corrateg E-Bike frame, Shadow Edge Tube 3.0, the bike is perfect for long tours across stick and stone. A load of up to 180 kg system weight is possible with this model. The low entry and the ergonomic components ensures comfort and safety in the same way.



LIFE *ecorrates*





CORRATEC LIFE

**„DAS BESTE TRAININGSGERÄT
FÜR EIN GESUNDES LEBEN“**

*„THE BEST TRAINING DEVICE
FOR A HEALTHY LIFE“*

**DR. MED.
LUDWIG VINCENT GEIGER**

**BEKANNTER SPORTMEDIZINER UND
ENTWICKLER DES CORRATEC LIFE.**

WELL KNOWN SPORTS PHYSICIAN AND
DEVELOPER OF CORRATEC LIFE.

KUNST DER BEWEGUNG ART OF MOVEMENT

Für den bekannten Sportmediziner war es eine Herzensangelegenheit, eine prophylaktische sowie kurative Therapie mit dem corrateg Life für seine Patienten zu entwickeln. Denn regelmäßige Bewegung erhöht die körperliche und geistige Leistungsfähigkeit, hilft dabei effizient Stress abzubauen, unterstützt die Erhaltung der Gesundheit, Beweglichkeit, kardiologische Funktionsfähigkeit und sorgt über allem für Lebensfreude. Detaillierte Informationen zu „Kunst der Bewegung“ finden Sie im gleichnamigen Buch.

The famous sports physician Ludwig V. Geiger created and introduced a prophylactic and curative therapy with the corrateg life for his patients. Because regular exercises increase physical and mental performance, helps to reduce stress efficiently, supports the maintenance of health, flexibility, cardiac and provides vitality.

Detailed information on „Art of Movement“ can be found in his homonymous book.



„DIE KUNST DER BEWEGUNG“

Von Dr. Ludwig V. Geiger, Entwickler des
corrateg Life.

Gebundene Ausgabe, 480 Seiten,

ISBN: 978-3-475-54329-6



FOCUS
E-BIKE
DESIGN AWARD

TOP
E-BIKE DESIGN
KATEGORIE: TREKKING

2022

www.focus-ebike.de

Sechs weitere Modelle erhielten
diese Auszeichnung

CORRATEC LIFE



180kg

Zulässiges Gesamtgewicht
Overall Systemweight

3.0
SHADOW
EDGE TUBE

750WH

Sensationelle Reichweite
Outstanding capacity



TIEFER EINSTIEG LOW ENTRY

Komfortabler und tiefer Einstieg um schnell und sicher vom Rad auf- und abzusteigen, als ein zusätzliches Sicherheits Feature. Die speziell entwickelte Rahmengeometrie erzielt ausreichend Spielraum bei plötzlichem Absteigen!

Comfortable and deep entry to get quick and safe on and off the bike. An additional safety feature for more secureness in the city traffic jam or on extended bike trips across stick and stone.

SICHERES BREMSSEN SAFE BRAKING

Um Ihnen noch mehr Sicherheit zu bieten, haben wir die Vorderbremse rot gestaltet. Absteigen über den Lenker oder ein rutschendes Vorderrad gehören der Vergangenheit an.

For more security the front brake is designed in corratec life red. Sliding front wheels and flips across the handlebar are things of the past.



SHADOW EDGE TUBE 3.0

Der weltweit stabilste und sicherste corratec E-Bike Rahmen geht in die nächste Runde. Mit einem einzigartigen Wabendesign und 750Wh Akku katapultiert das neue Unterrohr unsere corratec E-Bikes auf die nächste Ebene.

The worldwide most stable and safest corratec e-bike frame is entering the next round. With an unique honeycomb design and 750 Wh battery, the new down tube catapults our corratec e-bikes to the next level.



CORRATEC LIFE CX7 ABS

Extrem stabiler Shadow Edge Tube 3.0 Rahmen mit 180kg zulässigem Systemgewicht. Shadow Edge Tube 3.0 for an elegant integration of the 750 Wh Bosch battery.

Maximale Verwindungssteifigkeit mit dem neuen, voll integrierten Powertube 750Wh Akku. Outstanding: Permissible system weight up to 180 Kg.

Hochwertige Komponenten sorgen für ein ergonomisches Fahrgefühl. The E-Bike SUV – Amazing performance both on and off the road.

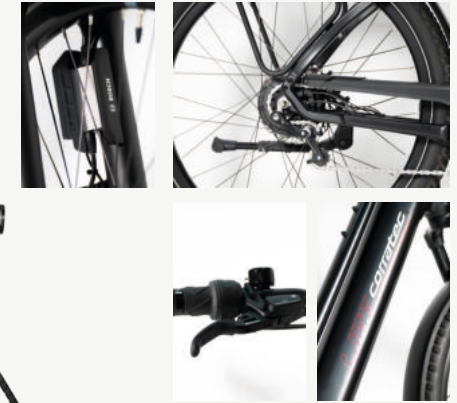

- Bosch Performance CX Cruise BES3 (25 km/h)
- Bosch Power Tube 750 Wh
- Bosch Kiox 500
- Corratec Life
- SR Suntour MOBIE34-AIR LOR DS 100mm
- Enviolo Trekking
- Enviolo Manual Controller
- Magura MT C ABS Allroad 203mm I Front
- Magura MT C ABS Allroad 180mm I Rear
- ZZYX E-Power Crank 38T
- Enviolo 20T
- KMC Z1
- ZZYX Life 650B I Front
- ZZYX Life 650B I Rear
- Schwalbe Johnny Watts 60-584 I Front
- Schwalbe Johnny Watts 60-584 I Rear
- SQ Lab 621 ERGOLUX active
- ZZYX SP Alloy Seatpost 30.9mm
- ZZYX SL Alloy Stem ICR
- ZZYX Corratec Life Handlebar

FARBE COLOR



Factory Copper | Pearlized Black



Silver | Cool Grey

BK29351

RAHMEN FRAME

CORRATEC LIFE | SHADOW EDGE TUBE 3.0

FEATURES

39 | 42 | 47 | 53 | 57

UVP RRP 5.999 EUR

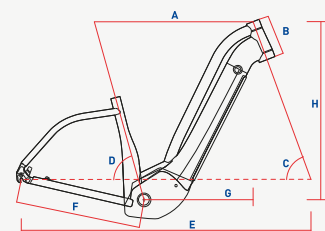

CM	A	B	C	D	E	F	G	H
39	594	160	68	77	1182	460	443	654
42	601	170	68	77	1190	460	448	663
47	608	180	68	77	1199	460	453	672
53	617	190	69	77	1197	460	458	687
57	624	200	69	77	1206	460	463	696



Bilder dienen nur als Veranschaulichung
Images are for illustrative purposes only

CORRATEC LIFE CX7

Extrem stabiler Shadow Edge Tube 3.0 Rahmen mit 180kg zulässigem Systemgewicht. Shadow Edge Tube 3.0 for an elegant integration of the 750 Wh Bosch battery.

Maximale Verwindungssteifigkeit mit dem neuen, voll integrierten Powertube 750Wh Akku. Outstanding: Permissible system weight up to 180 Kg.

Hochwertige Komponenten sorgen für ein ergonomisches Fahrgefühl. The E-Bike SUV – Amazing performance both on and off the road.

750
Wh



- Bosch Performance CX Cruise BES3 (25 km/h)
- Bosch Power Tube 750 Wh
- Bosch Kiox 500
- corratec Life
- SR Suntour MOBIE25-AIR LOR DS 100mm
- Enviolo Trekking
- Enviolo Manual Controller
- Magura MT Thirty 203mm I Front
- Magura MT Thirty 180mm I Rear
- ZYZX E-Power Crank 38T
- Enviolo 20T
- KMC Z1
- ZYZX Life 650B I Front
- ZYZX Life 650B I Rear
- Schwalbe Johnny Watts 60-584 I Front
- Schwalbe Johnny Watts 60-584 I Rear
- SQ Lab 621 ERGOLUX active
- ZYZX SP Alloy Seatpost 30.9mm
- ZYZX SL Alloy Stem ICR
- ZYZX corratec Life Handlebar

FARBE COLOR

Factory Copper | Pearlized Black

Silver | Cool Grey

BK29350

RAHMEN FRAME

CORRATEC LIFE | SHADOW EDGE TUBE 3.0

FEATURES

39 | 42 | 47 | 53 | 57

UVP RRP 5.299 EUR

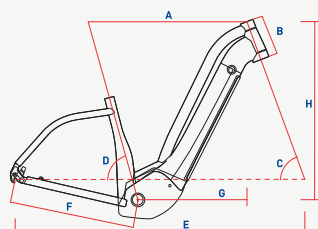

CM	A	B	C	D	E	F	G	H
39	594	160	68	77	1182	460	443	654
42	601	170	68	77	1190	460	448	663
47	608	180	68	77	1199	460	453	672
53	617	190	69	77	1197	460	458	687
57	624	200	69	77	1206	460	463	696

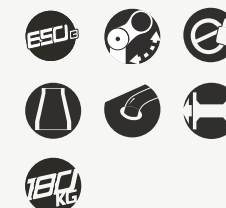

Bilder dienen nur als Veranschaulichung
Images are for illustrative purposes only



CORRATEC LIFE CX7 12S ABS

Extrem stabiler Shadow Edge Tube 3.0 Rahmen mit 180kg zulässigem Systemgewicht. Shadow Edge Tube 3.0 for an elegant integration of the 750 Wh Bosch battery.

Maximale Verwindungssteifigkeit mit dem neuen, voll integrierten Powertube 750Wh Akku. Outstanding: Permissible system weight up to 180 Kg.

Hochwertige Komponenten sorgen für ein ergonomisches Fahrgefühl. The E-Bike SUV – Amazing performance both on and off the road.



Bilder dienen nur als Veranschaulichung
Images are for illustrative purposes only

- Bosch Performance CX Cruise BES3 (25 km/h)
- Bosch Power Tube 750Wh
- Bosch Kiox 500
- Corratec Life
- SR Suntour MOBIE34-AIR LOR DS 100mm
- Sram SX Eagle 12S
- Sram SX Eagle 12S
- Magura MT C ABS Allroad 203mm I Front
- Magura MT C ABS Allroad 203mm I Rear
- Sram X-Sync 38T
- Sram PG1210 Eagle 11-50T 12S
- Sram SX Eagle 12S
- ZZYX Life 650B I Front
- ZZYX Life 650B I Rear
- Schwalbe Johnny Watts 60-584 I Front
- Schwalbe Johnny Watts 60-584 I Rear
- SQ Lab 621 ERGOLUX active
- ZZYX Suspension Seatpost 30.9mm
- ZZYX SL Alloy Stem ICR
- ZZYX Corratec Life Handlebar

FARBE COLOR



Factory Copper | Pearlized Black



Silver | Cool Grey

BK29354

RAHMEN FRAME

CORRATEC LIFE | SHADOW EDGE TUBE 3.0

FEATURES

39 | 42 | 47 | 53 | 57

UVP RRP 5.799 EUR

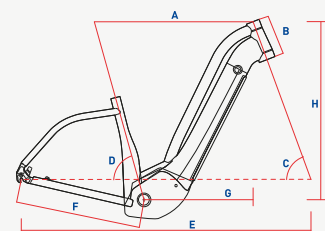

CM	A	B	C	D	E	F	G	H
39	594	160	68	77	1182	460	443	654
42	601	170	68	77	1190	460	448	663
47	608	180	68	77	1199	460	453	672
53	617	190	69	77	1197	460	458	687
57	624	200	69	77	1206	460	463	696



CORRATEC LIFE CX7 12S

Extrem stabiler Shadow Edge Tube 3.0 Rahmen mit 180kg zulässigem Systemgewicht. Shadow Edge Tube 3.0 for an elegant integration of the 750 Wh Bosch battery.

Maximale Verwindungssteifigkeit mit dem neuen, voll integrierten Powertube 750Wh Akku. Outstanding: Permissible system weight up to 180 Kg.

Hochwertige Komponenten sorgen für ein ergonomisches Fahrgefühl. The E-Bike SUV – Amazing performance both on and off the road.

750
Wh



- Bosch Performance CX Cruise BES3 (25 km/h)
- Bosch Power Tube 750Wh
- Bosch Kiox 500
- corratec Life
- SR Suntour MOBIET5-AIR LOR DS 100mm
- Sram SX Eagle 12S
- Sram SX Eagle 12S
- Magura MT Thirty 203mm I Front
- Magura MT Thirty 180mm I Rear
- Sram X-Sync 38T
- Sram PG1210 Eagle 11-50T 12S
- Sram SX Eagle 12S
- ZZYX Life 650B I Front
- ZZYX Life 650B I Rear
- Schwalbe Johnny Watts 55-584 I Front
- Schwalbe Johnny Watts 55-584 I Rear
- SQ Lab 621 ERGOLUX active
- ZZYX Suspension Seatpost 30.9mm
- ZZYX SL Alloy Stem ICR
- ZZYX corratec Life Handlebar

FARBE COLOR

Factory Copper | Pearlized Black

Silver | Cool Grey

BK29353

RAHMEN FRAME

CORRATEC LIFE | SHADOW EDGE TUBE 3.0

FEATURES

39 | 42 | 47 | 53 | 57

UVP RRP **4.999 EUR**

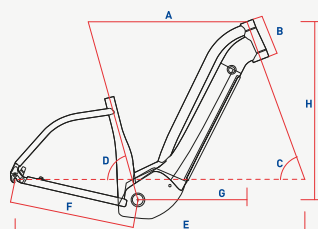

CM	A	B	C	D	E	F	G	H
39	594	160	68	77	1182	460	443	654
42	601	170	68	77	1190	460	448	663
47	608	180	68	77	1199	460	453	672
53	617	190	69	77	1197	460	458	687
57	624	200	69	77	1206	460	463	696

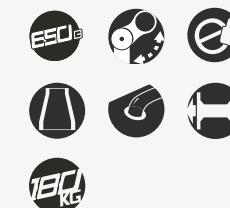

Bilder dienen nur als Veranschaulichung
Images are for illustrative purposes only



CORRATEC LIFE CX7 BELT

Extrem stabiler Shadow Edge Tube 3.0 Rahmen mit 180kg zulässigem Systemgewicht. Extremely stable Shadow Edge Tube 3.0 frame: permissible system weight up to 180 Kg.

Maximale Verwindungssteifigkeit mit dem form-schönen, voll integrierten Powertube 750Wh. Maximum torsional stiffness with the fully integrated 750Wh Powertube battery.

Enviolo Trekking Nabenschaltung ermöglicht stufenloses Schalten. Enviolo trekking hub gear enables stepless shifting.

750 Wh



- Bosch CX Cruise BES3
- Bosch PowerTube 750 Wh
- Bosch Kiox 500 Display
- Corratec Life
- SR Suntour MOBIE25 AIR LOR DS 27.5" 100mm
- Enviolo Trekking
- Enviolo Manual Controller
- Magura MT Thirty 4 Piston 203 mm
- Magura MT Thirty 2 Piston 180 mm
- Gates 46T
- Gates 22T
- Carbon drive belt 118T
- ZZYX 650B I Front
- ZZYX 650B I Rear
- Schwalbe Johnny Watts 60-584 I Front
- Schwalbe Johnny Watts 60-584 I Rear
- SQ Lab 621 ERGOLUX active
- ZZYX Alloy Seatpost 30,9 x 350mm
- ZZYX SL Alloy Stem
- ZZYX Life Handlebar

FARBE COLOR



Factory Copper | Pearlized Black



Silver | Cool Grey

BK29352

39 | 42 | 47 | 53 | 57

UVP RRP 5.799 EUR

RAHMEN FRAME

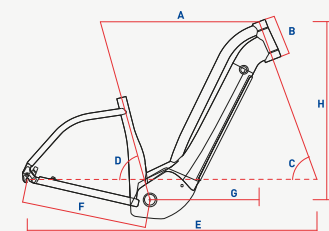

CORRATEC LIFE | SHADOW EDGE TUBE 3.0

CM	A	B	C	D	E	F	G	H
39	594	160	68	77	1182	460	443	654
42	601	170	68	77	1190	460	448	663
47	608	180	68	77	1199	460	453	672
53	617	190	69	77	1197	460	458	687
57	624	200	69	77	1206	460	463	696

FEATURES



Bilder dienen nur als Veranschaulichung
Images are for illustrative purposes only

CORRATEC LIFE CX6 12S

Extrem stabiler Shadow Edge Tube 3.0 Rahmen mit 180kg zulässigem Systemgewicht. Outstanding: Permissible system weight up to 180 Kg.

Maximale Verwindungssteifigkeit mit dem neuen, voll integrierten Powertube 625Wh. Shadow Edge Tube 3.0 for an elegant integration of the 750 Wh Bosch battery.

Hochwertige Komponenten sorgen für ein ergonomisches Fahrgefühl. The E-Bike SUV – Amazing performance both on and off the road.

625
Wh



- Bosch Performance CX Cruise BES3 (25 km/h)
- Bosch Power Tube 625Wh
- Bosch Intuvia 100
- corratec Life
- SR Suntour MOBIET5-AIR LOR DS 100mm
- Sram SX Eagle 12S
- Sram SX Eagle 12S
- Magura MT Thirty 203mm | Front
- Magura MT Thirty 180mm | Rear
- Sram X-Sync 38T
- Sram PG1210 Eagle 11-50T 12S
- Sram SX Eagle 12S
- ZYZX Life 650B | Front
- ZYZX Life 650B | Rear
- Continental Race King 55-584 | Front
- Continental Race King 55-584 | Rear
- SQ Lab 621 ERGOLUX active
- ZYZX Alloy Seatpost 30,9 x 350mm
- ZYZX SL Alloy Stem ICR
- ZYZX corratec Life Handlebar

FARBE COLOR

Factory Copper | Pearlized Black

Silver | Cool Grey

BK29355

39 | 42 | 47 | 53 | 57

UVP RRP 4.599 EUR

RAHMEN FRAME

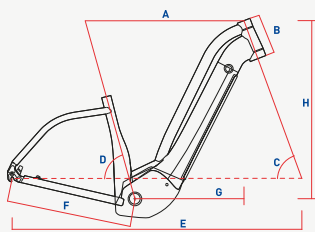

CORRATEC LIFE | SHADOW EDGE TUBE 3.0

CM	A	B	C	D	E	F	G	H
39	594	160	68	77	1182	460	443	654
42	601	170	68	77	1190	460	448	663
47	608	180	68	77	1199	460	453	672
53	617	190	69	77	1197	460	458	687
57	624	200	69	77	1206	460	463	696

FEATURES

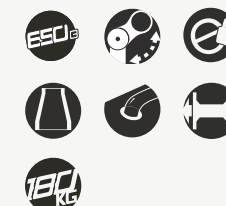

Bilder dienen nur als Veranschaulichung
Images are for illustrative purposes only

TREKKING

—E-BIKE—

Um Deinen hohen Ansprüchen gerecht zu werden, entwickeln wir hochfunktionelle E-Trekking Bikes mit modernsten Technologien. Unsere E-Trekking Bike Range bietet Dir komfortable Tiefeinsteiger bis hin zu 26 Zoll City – Cruisern. Zusätzlich garantiert Dir unsere C29 S-Pedelec Serie bei längeren Pendelfahrten ein entspanntes Ankommen am Arbeitsplatz. Bei Deinen sportlichen Ausfahrten oder genüsslichen Touren ist das Rad Dein zuverlässiger Partner. Oberste Priorität ist es für uns, Dich mit Deinem Rad sicher und entspannt ans Ziel zu bringen.

In order to meet your expectations, we develop highly functional E-Trekking bikes with the latest technologies. Our range offers you comfortable 26 inch city cruisers. In addition, our C29 Pedelec series are the perfect bikes for daily commuting. Whether you go for a sporty ride or would like to do a multiple days trip in good company, with our E-Trekking bikes you are perfectly prepared at any time. Moreover our main purpose is that you feel safe and comfortable on your bike.

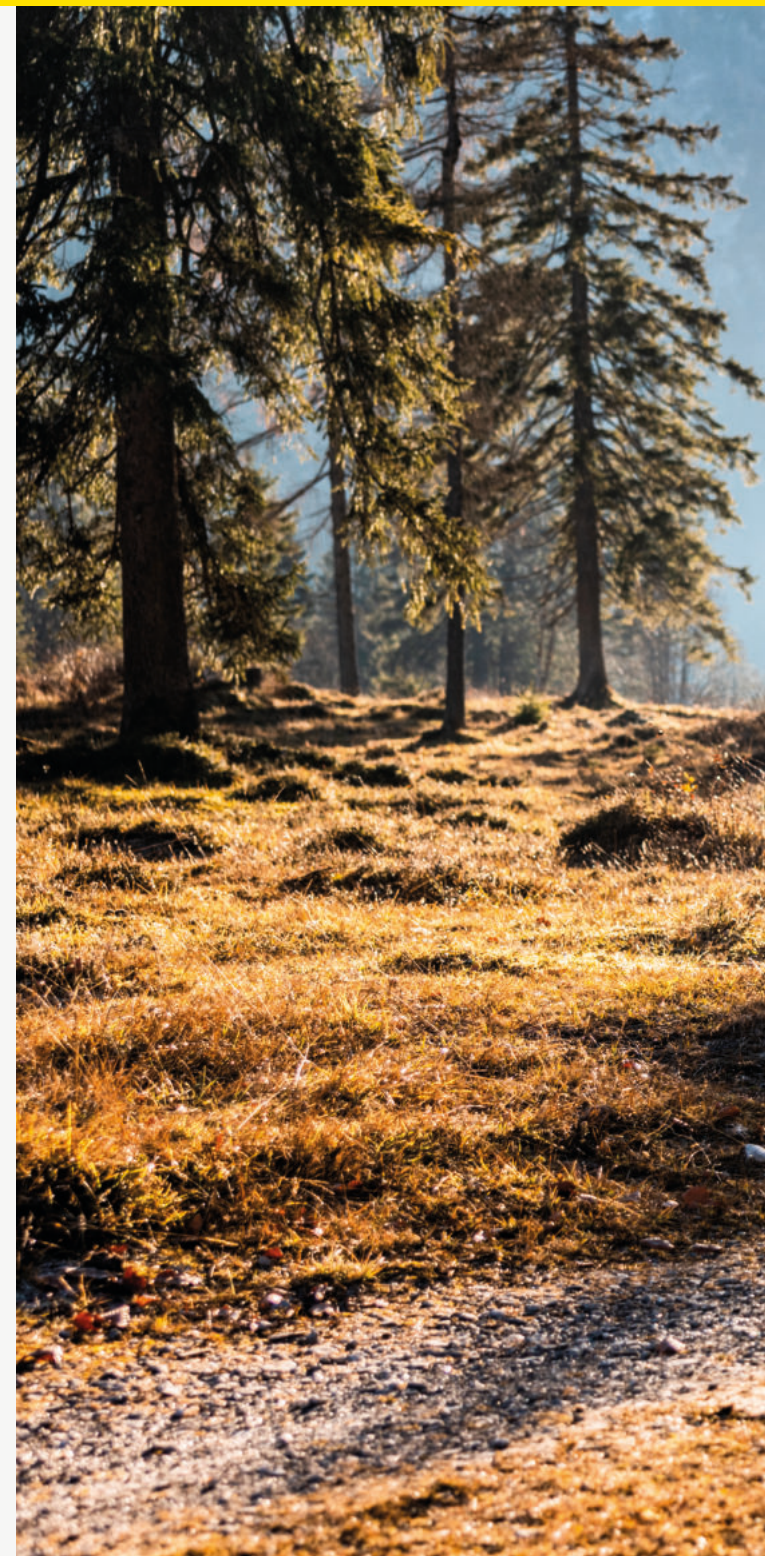





CORRATEC C29 SE 3.0 CX7 BELT SPORT

Premium Trekkingbike mit wartungsarmen und langlebigen Riemenantrieb. Premium trekking bike with low-maintenance and durable belt drive.

Die dämpfende 29 Zoll Ballonbereifung sorgt für ein angenehmes Cruisen auch auf Schotterstraßen. 29" balloon tyres for riding effortlessly on gravel roads.

Shadow Edge Tube 3.0 – weltweit stabilster und sicherster corratec E-Bike Rahmen. Shadow Edge Tube 3.0 – world's most stable and safest corratec E-Bike Frame.

750 Wh



- Bosch CX Cruise BES3
- Bosch PowerTube 750 Wh
- Bosch Kiox 300 Display
- E-Power C29 Sport
- E-Power C29 Fork
- Enviolo Trekking
- Enviolo Manual Controller
- Magura MT Thirty 4 piston 180 mm | Front
- Magura MT Thirty 2 piston 180 mm | Rear
- Gates Crank 46T
- Gates 22T
- Carbon Drive Belt 122T
- ZZYZX Sport 29" | Front
- ZZYZX Sport 29" | Rear
- Continental Contact Cruiser 29 x 2,20" | Front
- Continental Contact Cruiser 29 x 2,20" | Rear
- Selle Royal Essenza Relaxed
- ZZYZX Alloy Seatpost 30,9 x 350mm
- Speedlifter Classic Stem
- ZZYZX Alloy Handlebar

FARBE COLOR

Chrome | Cool Gray

BK29340

RAHMEN FRAME

E-POWER C29 SPORT | SHADOW EDGE TUBE 3.0

FEATURES

45 | 50 | 55

UVP RRP 5.299 EUR

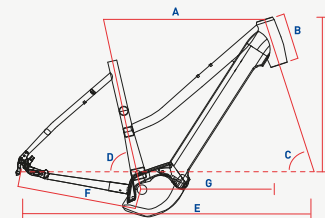

CM	A	B	C	D	E	F	G	H
45	617	170	69	74	1159	465	420	665
50	626	180	69	74	1168	465	426	675
55	645	190	69	74	1188	465	442	684



Das Rendering dient nur als Referenz
The Rendering is for Reference only

CORRATEC C29 SE 3.0 CX7 BELT GENT

Premium Trekkingbike mit wartungsarmen und langlebigen Riemenantrieb. Premium trekking bike with low-maintenance and durable belt drive.

Die dämpfende 29 Zoll Ballonbereifung sorgt für ein angenehmes Cruisen auch auf Schotterstraßen. 29" balloon tyres for riding effortlessly on gravel roads.

12 Gang Kettenschaltung von Sram für bergiges Gelände. Sram 12-speed derailleur for mountainous terrain.

750
Wh



- Bosch CX Cruise BES3
- Bosch PowerTube 750 Wh
- Bosch Kiox 300 Display
- E-Power C29 Gent
- E-Power C29 Fork
- Enviolo Trekking
- Enviolo Manual Controller
- Magura MT Thirty 4 piston 180 mm | Front
- Magura MT Thirty 2 piston 180 mm | Rear
- Gates Crank 46T
- Gates 22T
- Carbon Drive Belt 122T
- ZYZX Sport 29" | Front
- ZYZX Sport 29" | Rear
- Continental Contact Cruiser 29" x 2,20" | Front
- Continental Contact Cruiser 29" x 2,20" | Rear
- Selle Royal Essenza Relaxed
- ZYZX Alloy Seatpost 30,9 x 350mm
- Speedlifter Classic Stem
- ZYZX Alloy Handlebar

ePOWER C29er

FARBE COLOR

Chrome | Cool Gray

BK29341

RAHMEN FRAME

E-POWER C29 GENT | SHADOW EDGE TUBE 3.0

FEATURES

50 | 55 | 60

UVP RRP **5.299 EUR**

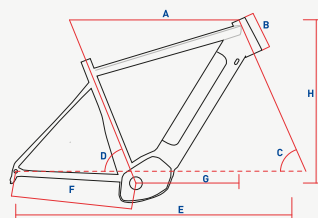

CM	A	B	C	D	E	F	G	H
50	625	160	69	73	1160	465	425	654
55	633	170	69	73	1169	465	430	663
60	641	180	69	73	1177	465	435	673



Bilder dienen nur als Veranschaulichung
Images are for illustrative purposes only



CORRATEC C29 SE 3.0 CX7 12S SPORT

Das absolute Premium-Highlight in dieser Produktreihe als komfortorientiertes Trekkingrad. The premium class among the trekking bikes – comfort optimized touring bike.

Die dämpfende 29 Zoll Ballonbereifung sorgt für ein angenehmes Cruisen auch auf Schotterstraßen. 29er balloon tyres for riding effortlessly on gravel roads.

Shadow Edge Tube 3.0 – weltweit stabilster und sicherster corratac E-Bike Rahmen. Shadow Edge Tube 3.0 – worldwide most stable and safest corratac E-Bike Frame.

750

Wh



- Bosch CX Cruise BES3
- Bosch PowerTube 750 Wh
- Bosch Intuvia 100 Display
- E-Power C29 Sport
- E-Power C29 Fork
- Sram SX Eagle
- Sram SX Eagle
- TEKTRO HD T275 180 mm
- TEKTRO HD T275 160 mm
- Sram X-Sync 38T
- Sram PG1210 Eagle 11-50T
- CN SX EAGLE
- ZZYZX Sport 29" I Front
- ZZYZX Sport 29" I Rear
- Continental Contact Cruiser 29" x 2,20" I Front
- Continental Contact Cruiser 29" x 2,20" I Rear
- Selle Royal Essenza Relaxed
- ZZYZX Alloy Seatpost 30,9 x 350mm
- Speedlifter Classic Stem
- ZZYZX Alloy Handlebar

ePOWER C29er

FARBE COLOR

Dark Brown I Gold

BK29342

RAHMEN FRAME

E-POWER C29 SPORT | SHADOW EDGE TUBE 3.0

FEATURES

45 | 50 | 55

UVP RRP **4.299 EUR**

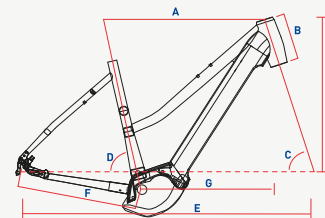

CM	A	B	C	D	E	F	G	H
45	617	170	69	74	1159	465	420	665
50	626	180	69	74	1168	465	426	675
55	645	190	69	74	1188	465	442	684



Bilder dienen nur als Veranschaulichung
Images are for illustrative purposes only

CORRATEC C29 SE 3.0 CX7 12S GENT

Das absolute Premium-Highlight in dieser Produktreihe als komfortorientiertes Trekkingrad. The premium class among the trekking bikes – comfort optimized touring bike.

Die dämpfende 29 Zoll Ballonbereifung sorgt für ein angenehmes Cruisen auch auf Schotterstraßen. 29er balloon tyres for riding effortlessly on gravel roads.

12 Gang Kettenschaltung von Sram für bergiges Gelände. Sram 12-speed derailleur for mountainous terrain.

750
Wh



- Bosch CX Cruise BES3
- Bosch PowerTube 750 Wh
- Bosch Intuvia 100 Display
- E-Power C29 Gent
- E-Power C29 Fork
- Sram SX Eagle
- Sram SX Eagle
- TEKTRO HD T275 180 mm
- TEKTRO HD T275 160 mm
- Sram X-Sync 38T
- Sram PG1210 Eagle 11-50T
- CN SX EAGLE
- ZZYX Sport 29" I Front
- ZZYX Sport 29" I Rear
- Continental Contact Cruiser 29" x 2,20" I Front
- Continental Contact Cruiser 29" x 2,20" I Rear
- Selle Royal Essenza Relaxed
- ZZYX Alloy Seatpost 30,9 x 350mm
- Speedlifter Classic Stem
- ZZYX Alloy Handlebar

FARBE COLOR

Dark Brown | Gold

BK29343

RAHMEN FRAME

E-POWER C29 GENT | SHADOW EDGE TUBE 3.0

FEATURES

50 | 55 | 60

UVP RRP **4.299 EUR**

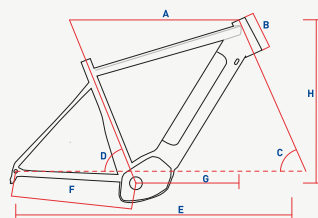

CM	A	B	C	D	E	F	G	H
50	625	160	69	73	1160	465	425	654
55	633	170	69	73	1169	465	430	663
60	641	180	69	73	1177	465	435	673



Das Rendering dient nur als Referenz
The Rendering is for Reference only



E-POWER SPORT 28 SE 3.0 CX7 12S SPORT

Der tiefe Einstieg bietet dem Fahrer zu jedem Zeitpunkt maximale Sicherheit und Kontrolle. The low entry offers the rider maximum safety and control at all times.

Shadow Edge Tube 3.0 - Weltweit stabilster und sicherster corratac E-Bike Rahmen. The newly developed Shadow Edge 3.0 frame construction ensures maximum rigidity and enables the new 750Wh battery to be removed easily.

Hochwertige Komponenten garantieren ein breites Spektrum für den individuellen Einsatzbereich. High quality components guarantee a wide range for the individual area of application.

750

Wh



- Bosch Performance CX Cruise BES3 (25 km/h)
- Bosch Power Tube 750Wh
- Bosch Kiox 300
- E-Power Sport 28 Trapez
- SR Suntour MOBIE25-AIR LOR DS 63mm
- Shimano Deore XT SGS 12S
- Shimano SLX 12S
- Shimano MT200 180mm | Front
- Shimano MT200 180mm | Rear
- ZZYX E-Power Crank 38T
- Shimano SLX 10-51T 12S
- KMC X12 12S
- ZZYX Sport HD 28" | Front
- ZZYX Sport HD 28" | Rear
- Schwalbe Land Cruiser 55-622 | Front
- Schwalbe Land Cruiser 55-622 | Rear
- Selle Royal Ariel Ladies
- ZZYX Suspension Seatpost 30.9mm
- ZZYX SL Alloy Stem 1CR
- ZZYX SL Alloy Handlebar

FARBE COLOR

Dark Blue | Mango | Light Grey

BK29332

RAHMEN FRAME

E-POWER SPORT 28 SPORT | SHADOW EDGE TUBE 3.0

FEATURES

45 | 50 | 55

UVP RRP **4.799 EUR**

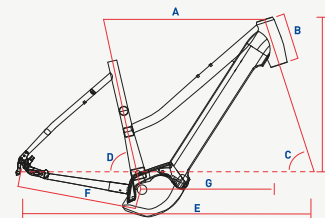

CM	A	B	C	D	E	F	G	H
45	613	170	69	74	1160	465	424	658
50	621	180	69	74	1170	465	430	667
55	630	190	69	74	1179	465	436	676



Das Rendering dient nur als Referenz
The Rendering is for Reference only

E-POWER SPORT 28 SE 3.0 CX7 12S GENT

Der hochwertige Aluminium Rahmen bietet höchstmögliche Sicherheit und Stabilität. High-quality aluminum frame for more safety and stability on tours and in traffic.

Maximale Verwindungssteifigkeit mit dem neuen, voll integrierten Powertube 750Wh Akku. Comfort optimized touring bike with suspension fork and suspension seatpost.

Shadow Edge Tube 3.0 – weltweit stabilster und sicherster corrated E-Bike Rahmen. Shadow Edge Tube 3.0- worldwide most stable and safest corrated E-Bike frame.

750
Wh



- Bosch Performance CX Cruise BES3 (25 km/h)
- Bosch Power Tube 750Wh
- Bosch Kiox 300
- E-Power Sport 28 Gent
- SR Suntour MOBIE25-AIR LOR DS 63mm
- Shimano Deore XT SGS 12S
- Shimano SLX 12S
- Shimano MT200 180mm I Front
- Shimano MT200 180mm I Rear
- ZYZX E-Power Crank 38T
- Shimano SLX 10-51T 12S
- KMC X12 12S
- ZYZX Sport HD 28" I Front
- ZYZX Sport HD 28" I Rear
- Schwalbe Land Cruiser 55-622 I Front
- Schwalbe Land Cruiser 55-622 I Rear
- Selle Royal Ariel Men
- ZYZX Suspension Seatpost 30.9mm
- ZYZX SL Alloy Stem ICR
- ZYZX SL Alloy Handlebar

FARBE COLOR

Dark Blue | Mango | Light Grey

BK29333

RAHMEN FRAME

E-POWER SPORT 28 GENT | SHADOW EDGE TUBE 3.0

FEATURES

50 | 55 | 60

UVP RRP **4.799 EUR**

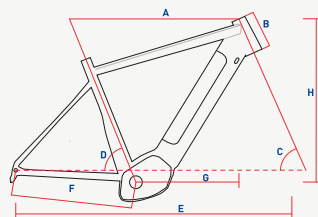

CM	A	B	C	D	E	F	G	H
50	630	160	68	73	1178	465	435	639
55	638	170	68	73	1187	465	440	648
60	646	180	68	73	1196	465	445	657

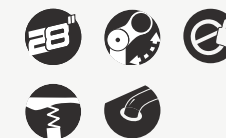

Bilder dienen nur als Veranschaulichung
Images are for illustrative purposes only



E-POWER SPORT 28 SE 3.0 CX7 12S SPORT

Der tiefe Einstieg bietet dem Fahrer zu jedem Zeitpunkt maximale Sicherheit und Kontrolle. The low entry offers the rider maximum safety and control at all times.

Shadow Edge Tube 3.0 - Weltweit stabilster und sicherster corratec E-Bike Rahmen. The newly developed Shadow Edge 3.0 frame construction ensures maximum rigidity and enables the new 750Wh battery to be removed easily.

Hochwertige Komponenten garantieren ein breites Spektrum für den individuellen Einsatzbereich. High quality components guarantee a wide range for the individual area of application.

750

Wh



- Bosch Performance CX Cruise BES3 (25 km/h)
- Bosch Power Tube 750Wh
- Bosch Kiox 300
- E-Power Sport 28 Trapez
- SR Suntour MOBIE25-COIL LOR DS 63mm
- SRAM SX 12s
- SRAM SX 12s
- Shimano MT200 180mm | Front
- Shimano MT200 180mm | Rear
- ZZYX E-Power Crank 38T
- SRAM PG1210
- SRAM SX 12s
- ZZYX Sport HD 28" | Front
- ZZYX Sport HD 28" | Rear
- Schwalbe Land Cruiser 55-622 | Front
- Schwalbe Land Cruiser 55-622 | Rear
- Selle Royal Ariel Ladies
- ZZYX Suspension Seatpost 30.9mm
- ZZYX SL Alloy Stem ICR
- ZZYX SL Alloy Handlebar

FARBE COLOR



Light Grey | Dark Blue | Cool Grey | Intense Red

BK29334

RAHMEN FRAME

E-POWER SPORT 28 SPORT | SHADOW EDGE TUBE 3.0

FEATURES

45 | 50 | 55

UVP RRP 4.299 EUR

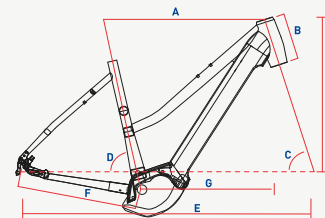

CM	A	B	C	D	E	F	G	H
45	613	170	69	74	1160	465	424	658
50	621	180	69	74	1170	465	430	667
55	630	190	69	74	1179	465	436	676



Das Rendering dient nur als Referenz
The Rendering is for Reference only

E-POWER SPORT 28 SE 3.0 CX7 12S GENT

Der hochwertige Aluminium Rahmen bietet höchstmögliche Sicherheit und Stabilität. High-quality aluminum frame for more safety and stability on tours and in traffic.

Maximale Verwindungssteifigkeit mit dem neuen, voll integrierten Powertube 750Wh Akku. Comfort optimized touring bike with suspension fork and suspension seatpost.

Shadow Edge Tube 3.0 – weltweit stabilster und sicherster corrated E-Bike Rahmen. Shadow Edge Tube 3.0- worldwide most stable and safest corrated E-Bike frame.

750 Wh



- Bosch Performance CX Cruise BES3 (25 km/h)
- Bosch Power Tube 750Wh
- Bosch Kiox 300
- E-Power Sport 28 Gent
- SR Suntour MOBIE25-COIL LOR DS 63mm
- SRAM SX 12s
- SRAM SX 12s
- Shimano MT200 180mm I Front
- Shimano MT200 180mm I Rear
- ZYZX E-Power Crank 38T
- SRAM PG1210
- SRAM SX 12s
- ZYZX Sport HD 28" I Front
- ZYZX Sport HD 28" I Rear
- Schwalbe Land Cruiser 55-622 I Front
- Schwalbe Land Cruiser 55-622 I Rear
- Selle Royal Ariel Men
- ZYZX Suspension Seatpost 30.9mm
- ZYZX SL Alloy Stem ICR
- ZYZX SL Alloy Handlebar

FARBE COLOR

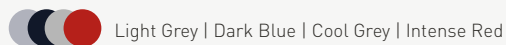

BK29335

RAHMEN FRAME

E-POWER SPORT 28 GENT | SHADOW EDGE TUBE 3.0

FEATURES

50 | 55 | 60

UVP RRP 4.299 EUR

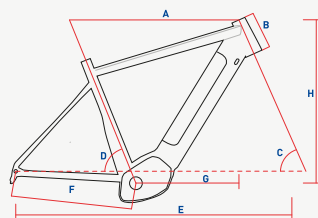

CM	A	B	C	D	E	F	G	H
50	630	160	68	73	1178	465	435	639
55	638	170	68	73	1187	465	440	648
60	646	180	68	73	1196	465	445	657

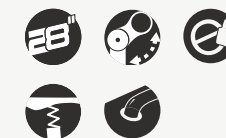

Das Rendering dient nur als Referenz
The Rendering is for Reference only

E-POWER TREKKING 28 SE 3.0 CX7 12S GENT

Der hochwertige Aluminium Rahmen bietet höchstmögliche Sicherheit und Stabilität. High-quality aluminum frame for more safety and stability on tours and in traffic.

Maximale Verwindungssteifigkeit mit dem neuen, voll integrierten Powertube 750Wh Akku. Comfort optimized touring bike with suspension fork and suspension seatpost.

Shadow Edge Tube 3.0 – weltweit stabilster und sicherster corrated E-Bike Rahmen. Shadow Edge Tube 3.0- worldwide most stable and safest corrated E-Bike frame.

750
Wh



- Bosch CX Cruise BES3
- Bosch PowerTube 750 Wh
- Bosch Kiox 300 Display
- E-Power Trekking 28 Gent
- NX1-32-Boost-Air LO DS 29" 80 mm
- Sram SX Eagle
- Sram SX Eagle
- TEKTRO HD M535 180 mm
- TEKTRO HD M535 180 mm
- Sram X-Sync 38T
- Sram PG1210 Eagle 11-50T
- CN SX EAGLE
- ZYZX Trekking 28" I Front
- ZYZX Trekking 28" I Rear
- Schwalbe Land Cruiser 28" x 2,15" I Front
- Schwalbe Land Cruiser 28" x 2,15" I Rear
- Selle Royal Ariel Men
- ZYZX Suspension Seatpost 30.9 x 350mm
- ZYZX SL Alloy Stem
- ZYZX Trekking Handlebar

FARBE COLOR



Metallic Light Sand | Dark Blue | Silver | Black

BK29331

RAHMEN FRAME

E-POWER TREKKING 28 GENT | SHADOW EDGE TUBE 3.0

FEATURES

50 | 55 | 60

UVP RRP **4.299 EUR**

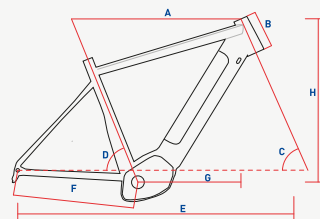

CM	A	B	C	D	E	F	G	H
50	617	170	69	74	1160	465	423	655
55	629	180	69	73	1166	465	426	664
60	638	190	69	73	1176	465	432	673



Bilder dienen nur als Veranschaulichung
Images are for illustrative purposes only



E-POWER TREKKING 28 CX6 12S WAVE

Der tiefe Einstieg bietet dem Fahrer zu jedem Zeitpunkt maximale Sicherheit und Kontrolle. The low entry offers the rider maximum safety and control at all times.

Maximale Verwindungssteifigkeit mit dem voll integrierten Powertube 625Wh Akku. Comfort optimized touring bike with suspension fork and suspension seatpost.

Shadow Edge Tube 3.0 – weltweit stabilster und sicherster corratec E-Bike Rahmen. Shadow Edge Tube 3.0 - worldwide most stable and safest corratec E-Bike frame.

625_{Wh}



E-POWER 28

- Bosch Performance CX Cruise BES3 (25 km/h)
- Bosch Power Tube 625Wh
- Bosch Intuvia 100
- E-Power Trekking 28 Wave
- SR Suntour NEX E25 DS 700C 63mm
- Sram SX Eagle 12S
- Sram SX Eagle 12S
- Shimano MT200 180mm I Front
- Shimano MT200 160mm I Rear
- Sram X-SYNC 38T
- Sram PG1210 Eagle 11-50T 12S
- Sram SX Eagle 12S
- ZZYZX Trekking HD 28" I Front
- ZZYZX Trekking HD 28" I Rear
- Schwalbe Land Cruiser 55-622 I Front
- Schwalbe Land Cruiser 55-622 I Rear
- Selle Royal Ariel Ladies
- ZZYZX Suspension Seatpost 30.9mm
- ZZYZX SL Alloy Stem
- ZZYZX Trekking Handlebar

FARBE COLOR



Marine Blue | Neon Red | Silver

BK29320

RAHMEN FRAME

E-POWER TREKKING 28 WAVE | SHADOW EDGE TUBE 3.0

FEATURES

45 | 50 | 55

UVP RRP **4.099 EUR**

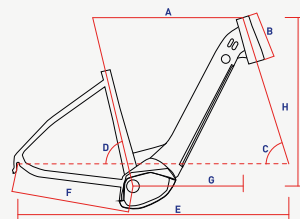

CM	A	B	C	D	E	F	G	H
45	601	180	68	74	1159	465	410	667
50	609	190	68	74	1168	465	415	676
55	617	200	68	74	1177	465	420	685



Das Rendering dient nur als Referenz
The Rendering is for Reference only

E-POWER TREKKING 28 CX6 12S GENT

Der hochwertige Aluminium Rahmen bietet höchstmögliche Sicherheit und Stabilität. High-quality aluminum frame for more safety and stability on tours and in traffic.

Maximale Verwindungssteifigkeit mit dem voll integrierten Powertube 625Wh Akku. Comfort optimized touring bike with suspension fork and suspension seatpost.

Shadow Edge Tube 3.0 – weltweit stabilster und sicherster corrateg E-Bike Rahmen. Shadow Edge Tube 3.0- worldwide most stable and safest corrateg E-Bike frame.

625
Wh



- Bosch Performance CX Cruise BES3 (25 km/h)
- Bosch Power Tube 625Wh
- Bosch Intuvia 100
- E-Power Trekking 28 Gent
- SR Suntour NEX E25 DS 700C 63mm
- Sram SX Eagle 12S
- Sram SX Eagle 12S
- Shimano MT200 180mm I Front
- Shimano MT200 160mm I Rear
- Sram X-SYNC 38T
- Sram PG1210 Eagle 11-50T 12S
- Sram SX Eagle 12S
- ZZYX Trekking HD 28" I Front
- ZZYX Trekking HD 28" I Rear
- Schwalbe Land Cruiser 55-622 I Front
- Schwalbe Land Cruiser 55-622 I Rear
- Selle Royal Ariel Men
- ZZYX Suspension Seatpost 30.9mm
- ZZYX SL Alloy Stem
- ZZYX Trekking Handlebar

FARBE COLOR

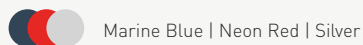

BK29321

RAHMEN FRAME

E-POWER TREKKING 28 GENT | SHADOW EDGE TUBE 3.0

FEATURES

50 | 55 | 60

UVP RRP **4.099 EUR**

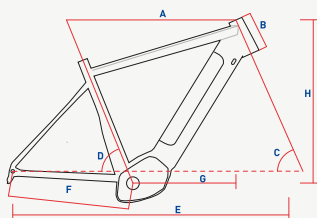

CM	A	B	C	D	E	F	G	H
50	617	170	69	74	1160	465	423	655
55	629	180	69	73	1166	465	426	664
60	638	190	69	73	1176	465	432	673

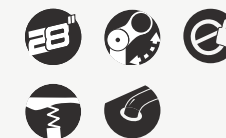

Das Rendering dient nur als Referenz
The Rendering is for Reference only



E-POWER TREKKING 28 P6 8S WAVE

Der tiefe Einstieg und die ergonomische Geometrie erzielen maximalen Fahrspaß bei Touren oder im Stadtverkehr. The low entry and the ergonomic geometry achieve maximum riding pleasure on tours and in city traffic.

Die verbauten Dämpfer in der Gabel und Sattelstütze bieten maximalen Komfort und Entlastung. Comfort optimized city bike with air fork and suspension seatpost.

Shadow Edge Tube 3.0 – weltweit stabilster und sicherster corratec E-Bike Rahmen. Shadow Edge Tube 3.0 – worldwide most stable and safest corratec E-Bike frame.

625

Wh



- Bosch Performance Line BES3
- Bosch Power Tube 625Wh
- Bosch Intuvia 100
- E-Power Trekking 28 Wave
- SR Suntour NEX E25 DS 700C 63mm
- Shimano Nexus 8S
- Shimano Nexus Revo Shifter 8S
- Shimano MT200 180mm I Front
- Shimano MT200 160mm I Rear
- ZZYZX E-Power Crank 38T
- Shimano 19T
- KMC Z1 8S
- ZZYZX Trekking HD 28" I Front
- ZZYZX Trekking HD 28" I Rear
- Schwalbe Land Cruiser 55-622 I Front
- Schwalbe Land Cruiser 55-622 I Rear
- Selle Royal Ariel Ladies
- ZZYZX Suspension Seatpost 30.9mm
- ZZYZX SL Alloy Stem
- ZZYZX Trekking Handlebar

FARBE COLOR



Green | Light Silver | Pearlized Black | Gray Blue

BK29322

RAHMEN FRAME

E-POWER TREKKING 28 WAVE | SHADOW EDGE TUBE 3.0

FEATURES

45 | 50 | 55

UVP RRP **3.799 EUR**

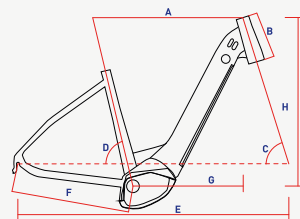

CM	A	B	C	D	E	F	G	H
45	600	180	69	73	1159	490	395	672
50	610	195	69	73	1170	490	401	686
55	620	210	69	73	1181	490	406	700



Bilder dienen nur als Veranschaulichung
Images are for illustrative purposes only

E-POWER TREKKING 28 P6 8SC WAVE

Der tiefe Einstieg und die ergonomische Geometrie erzielen maximalen Fahrspaß bei Touren oder im Stadtverkehr. The low entry and the ergonomic geometry achieve maximum riding pleasure on tours and in city traffic.

Die verbauten Dämpfer in der Gabel und Sattelstütze bieten maximalen Komfort und Entlastung. Comfort optimized city bike with air fork and suspension seatpost.

Shadow Edge Tube 3.0 Technologie - weltweit stabilster und sicherster corratac E-Bike Rahmen. Shadow Edge Tube 3.0 Technology - worldwide most stable and safest corratac E-Bike frame.

625
Wh



- Bosch Performance Line BES3
- Bosch Power Tube 625Wh
- Bosch Intuvia 100
- E-Power Trekking 28 Wave
- SR Suntour NEX E25 DS 700C 63mm
- Shimano Nexus 8S Coaster
- Shimano Nexus Revo Shifter 8S
- Shimano MT200 180mm I Front
- Shimano MT200 160mm I Rear
- Rücktrittbremse**
- ZZYZX E-Power Crank 38T
- Shimano 19T
- KMC Z1 8S
- ZZYZX Trekking HD 28" I Front
- ZZYZX Trekking HD 28" I Rear
- Schwalbe Land Cruiser 55-622 I Front
- Schwalbe Land Cruiser 55-622 I Rear
- Selle Royal Ariel Ladies
- ZZYZX Suspension Seatpost 30.9mm
- ZZYZX SL Alloy Stem
- ZZYZX Trekking Handlebar

FARBE COLOR



Gray | Metallic Gray | Pearlized Black | Silver

BK29323

RAHMEN FRAME

E-POWER TREKKING 28 WAVE | SHADOW EDGE TUBE 3.0

FEATURES

45 | 50 | 55 | 60

UVP RRP **3.799 EUR**

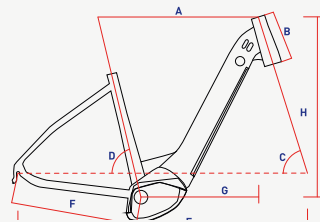

CM	A	B	C	D	E	F	G	H
50	610	195	69	73	1170	490	401	686
55	620	210	69	73	1181	490	406	700
60								



Bilder dienen nur als Veranschaulichung
Images are for illustrative purposes only



E-POWER URBAN 28 FUSION TUBE AP5 8SC WAVE

Der tiefe Einstieg und die ergonomische Geometrie erzielen maximalen Fahrspaß bei Touren oder im Stadtverkehr. The low entry and the ergonomic geometry achieve maximum riding pleasure on tours and in city traffic.

Die verbauten Dämpfer in der Gabel und Sattelstütze bieten maximalen Komfort und Entlastung. Comfort optimized city bike with air fork and suspension seatpost.

Fusion Tube Edge Technologie - weltweit stabiler und sicherster corrated E-Bike Rahmen. Fusion Tube Edge Technology - world's most stable and Safest corrated e-bike frame.

- Bosch Active Line Plus BES3
- Bosch PowerPack 545 Wh
- Bosch Intuvia 100 Display
- E-Power Urban 28 Wave
- SR Suntour NEX E25 DS 700C 63mm
- Shimano Nexus 8s
- Shimano Nexus 8s Revo
- Shimano, MT200 180 mm
- Shimano, MT200 160 mm
- ZYZX E-Power Crank 38T
- Shimano Nexus 19T 8s
- KMC Z1 Narrow EPT
- ZYZX Urban 28" | Front
- ZYZX Urban 28" | Rear
- Schwalbe Energizer Active Plus 28" x 2" | Front
- Schwalbe Energizer Active Plus 28" x 2" | Rear
- Selle Royal Orbis
- ZYZX Suspension Seatpost 30.9 x 350mm
- ZYZX SL Alloy Stem
- ZYZX Urban Handlebar



Das Rendering dient nur als Referenz
The Rendering is for Reference only

FARBE COLOR



Dark Blue | Light Blue | Silver

BK29310

RAHMEN FRAME

E-POWER URBAN 28 WAVE | FUSION TUBE EDGE

FEATURES

45 | 50 | 55

UVP RRP **3.399 EUR**

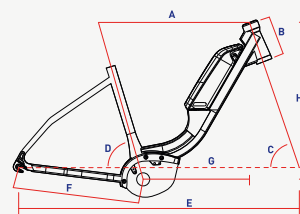

CM	A	B	C	D	E	F	G	H
45	590	180	69	73	1149	490	385	672
50	600	195	69	73	1160	490	391	686
55	610	210	69	73	1172	490	397	700



E-POWER URBAN 28 FUSION TUBE AP5 8S WAVE

Der tiefe Einstieg und die ergonomische Geometrie erzielen maximalen Fahrspaß bei Touren oder im Stadtverkehr. The low entry and the ergonomic geometry achieve maximum riding pleasure on tours and in city traffic.

Die verbauten Dämpfer in der Gabel und Sattelstütze bieten maximalen Komfort und Entlastung. Comfort optimized city bike with air fork and suspension seatpost.

Fusion Tube Edge Technologie - weltweit stabilster und sicherster corrated E-Bike Rahmen. Fusion Tube Edge Technology - world's most stable and Safest corrated e-bike frame.



- Bosch Active Line Plus BES3
- Bosch PowerPack 545 Wh
- Bosch Intuvia 100 Display
- E-Power Urban 28 Wave
- SR Suntour NEX E25 DS 700C 63mm
- Shimano Nexus 8s
- Shimano Nexus 8s Revo
- Shimano, MT200 180 mm
- Shimano, MT200 160 mm
- ZYZX E-Power Crank 38T
- Shimano Nexus 19T 8S
- KMC Z1 Narrow EPT
- ZYZX Urban 28" | Front
- ZYZX Urban 28" | Rear
- Schwalbe Energizer Active Plus 28" x 2" | Front
- Schwalbe Energizer Active Plus 28" x 2" | Rear
- Selle Royal Orbis
- ZYZX Suspension Seatpost 30.9 x 350mm
- ZYZX SL Alloy Stem
- ZYZX Urban Handlebar

FARBE COLOR

Dark Brown | Silver | Anthracite

BK29311

RAHMEN FRAME

E-POWER URBAN 28 WAVE | FUSION TUBE EDGE

FEATURES

50 | 55 | 60

UVP RRP **3.399 EUR**

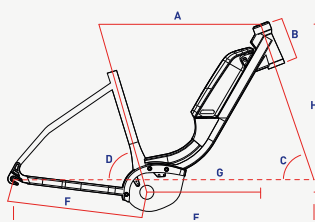

CM	A	B	C	D	E	F	G	H
50	600	195	69	73	1160	490	391	686
55	610	210	69	73	1172	490	397	700
60								

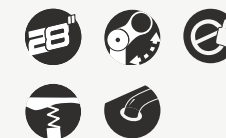

Das Rendering dient nur als Referenz
The Rendering is for Reference only



E-POWER URBAN 28 FUSION TUBE AP5 12S WAVE

Maximales Vertrauen durch einen extrem tiefen Einstieg, um schnellstmöglich auf- und abzustiegen. Low step-through to get on and off the bike as quickly as possible.

Durchstiegsschutz aus hochwertigem Kunststoff und zusätzlich glasfaserverstärkt. Step-through cover made of high-quality elastomer and additional fiberglass reinforcement.

Direct Mount Gepäckträger bis 25kg belastbar mit stylish integriertem Rücklicht. Direct mount luggage carrier with a load capacity of up to 25kg with a stylish integrated rear light.



- Bosch Active Line Plus BES3
- Bosch PowerPack 545 Wh
- Bosch Intuvia 100 Display
- E-Power Urban 28 Wave
- SR Suntour NEX E25 DS 700C 63mm
- Sram SX Eagle
- L-TW00 SL A11X 11S
- Shimano, MT200 180 mm
- Shimano, MT200 160 mm
- Sram X-SYNC 38T Chainring
- Sram PG1210 Eagle 11-50T
- CN SX Eagle
- ZZYZX Urban 28" | Front
- ZZYZX Urban 28" | Rear
- Schwalbe Energizer Active Plus 28" x 2" | Front
- Schwalbe Energizer Active Plus 28" x 2" | Rear
- Selle Royal Orbis
- ZZYZX Suspension Seatpost 30.9 x 350mm
- ZZYZX SL Alloy Stem
- ZZYZX Urban Handlebar

FARBE COLOR

Silver | Turquoise | Anthracite

BK29312

RAHMEN FRAME

50 | 55 | 60

UVP RRP **3.399 EUR**

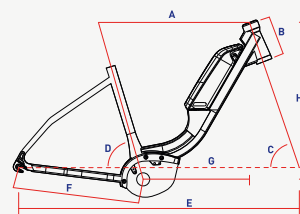

E-POWER URBAN 28 WAVE | FUSION TUBE EDGE

FEATURES

CM	A	B	C	D	E	F	G	H
50	605	160	69	73	1163	490	406	653
55	615	175	69	73	1174	490	412	667
60	625	190	69	73	1185	490	417	681



Das Rendering dient nur als Referenz
The Rendering is for Reference only

E-POWER URBAN 28 FUSION TUBE AP5 12S GENT

Maximales Vertrauen durch einen extrem tiefen Einstieg, um schnellstmöglich auf- und abzusteigen. Low step-through to get on and off the bike as quickly as possible.

Durchstiegsschutz aus hochwertigem Kunststoff und zusätzlich glasfaserverstärkt. Step-through cover made of high-quality elastomer and additional fiberglass reinforcement.

Direct Mount Gepäckträger bis 25kg belastbar mit stylisch integriertem Rücklicht. Direct mount luggage carrier with a load capacity of up to 25kg with a stylish integrated rear light.

-  Bosch Active Line Plus BES3
-  Bosch PowerPack 545 Wh
-  Bosch Intuvia 100 Display
-  E-Power Urban 28 Gent
-  SR Suntour NEX E25 DS 700C 63mm
-  Sram SX Eagle
-  Sram SX Eagle
-  Shimano, MT200 180 mm
-  Shimano, MT200 160 mm
-  Sram X-SYNC 38T Chainring
-  Sram PG1210 Eagle 11-50T
-  CN SX Eagle
-  ZZYZX Urban 28" | Front
-  ZZYZX Urban 28" | Rear
-  Schwalbe Energizer Active Plus 28" x 2" | Front
-  Schwalbe Energizer Active Plus 28" x 2" | Rear
-  Selle Royal Ariel Men
-  ZZYZX Suspension Seatpost 30.9 x 350mm
-  ZZYZX SL Alloy Stem
-  ZZYZX Urban Handlebar

MORE INFORMATION COMING SOON...

2024

E-POWER₂₈

FARBE COLOR



BK29313

RAHMEN FRAME

E-POWER URBAN 28 WAVE | FUSION TUBE EDGE

FEATURES

 50 | 55 | 60

UVP RRP **3.399 EUR**

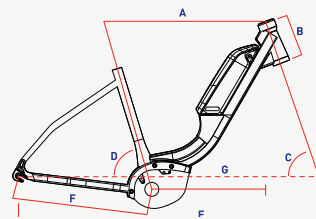

CM	A	B	C	D	E	F	G	H
50	605	160	69	73	1163	490	406	653
55	615	175	69	73	1174	490	412	667
60	625	190	69	73	1185	490	417	681



Das Rendering dient nur als Referenz
The Rendering is for Reference only



E-POWER URBAN 26 FUSION TUBE AP5 8SC WAVE

Maximales Vertrauen durch einen extrem tiefen Einstieg, um schnellstmöglich auf- und abzustiegen. Low step-through to get on and off the bike as quickly as possible.

Durchstiegsschutz aus hochwertigem Kunststoff und zusätzlich glasfaserverstärkt. Step-through cover made of high-quality elastomer and additional fiberglass reinforcement.

Direct Mount Gepäckträger bis 25kg belastbar mit stylish integriertem Rücklicht. Direct mount luggage carrier with a load capacity of up to 25kg with a stylish integrated rear light.



- Bosch Active Line Plus BES3
- Bosch PowerPack 545 Wh
- Bosch Intuvia 100 Display
- E-Power Urban 26 Wave
- SR Suntour NEX DS 26" 63mm
- Shimano Nexus 8s
- Shimano C6000 Nexus 8s Revo
- Shimano, MT200 180 mm
- Shimano, MT200 160 mm
- ZZYZX E-Power Crank 38T
- Shimano Nexus 19T 8s
- KMC Z1 Narrow EPT
- ZZYZX Urban 26" 1 Front
- ZZYZX Urban 26" 1 Rear
- Schwalbe Delta Cruiser Plus 26" x 2" 1 Front
- Schwalbe Delta Cruiser Plus 26" x 2" 1 Rear
- Selle Royal Orbis
- ZZYZX Suspension Seatpost 30.9 x 350mm
- ZZYZX SL Alloy Stem
- ZZYZX Urban Handlebar

FARBE COLOR



Night Black | Silver | Anthracite | Dark Red

BK29300

RAHMEN FRAME

E-POWER URBAN 26 WAVE | FUSION TUBE EDGE

FEATURES

40 | 45 | 50

VVP RRP 3.299 EUR

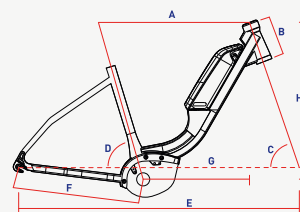

CM	A	B	C	D	E	F	G	H
40	590	175	70	73	1122	460	402	617
45	610	180	70	73	1142	460	421	621
50	615	195	70	73	1148	460	421	635



Bilder dienen nur als Veranschaulichung
Images are for illustrative purposes only

E-POWER URBAN 26 FUSION TUBE AP5 12S WAVE

Maximales Vertrauen durch einen extrem tiefen Einstieg, um schnellstmöglich auf- und abzusteigen. Low step-through to get on and off the bike as quickly as possible.

Durchstiegsschutz aus hochwertigem Kunststoff und zusätzlich glasfaserverstärkt. Step-through cover made of high-quality elastomer and additional fiberglass reinforcement.

Direct Mount Gepäckträger bis 25kg belastbar mit stylisch integriertem Rücklicht. Direct mount luggage carrier with a load capacity of up to 25kg with a stylish integrated rear light.

-  Bosch Active Line Plus BES3
-  Bosch PowerPack 545 Wh
-  Bosch Intuvia 100 Display
-  E-Power Urban 26 Wave
-  SR Suntour NEX DS 26" 63mm
-  SRAM SX Eagle
-  SRAM SX Eagle
-  Shimano, MT200 180 mm
-  Shimano, MT200 160 mm
-  SRAM X-SYNC 38T Chainring
-  SRAM PG1210 Eagle 11-50T
-  CN SX Eagle
-  ZZYZX Urban 26" 1 Front
-  ZZYZX Urban 26" 1 Rear
-  Schwalbe Delta Cruiser Plus 26" x 2" 1 Front
-  Schwalbe Delta Cruiser Plus 26" x 2" 1 Rear
-  Selle Royal Orbis
-  ZZYZX Suspension Seatpost 30.9 x 350mm
-  ZZYZX SL Alloy Stem
-  ZZYZX Urban Handlebar

MORE INFORMATION COMING SOON...

2024

E-POWER₂₈

FARBE COLOR



BK29301

RAHMEN FRAME

E-POWER URBAN 26 WAVE | FUSION TUBE EDGE

FEATURES

 40 | 45 | 50

UVP RRP **3.299 EUR**

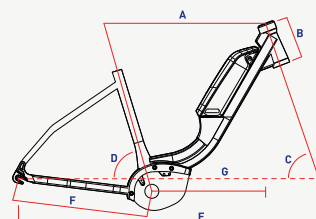

CM	A	B	C	D	E	F	G	H
40	590	175	70	73	1122	460	402	617
45	610	180	70	73	1142	460	421	621
50	615	195	70	73	1148	460	421	635



Das Rendering dient nur als Referenz
The Rendering is for Reference only



THE ROADBIKE

Du bist süchtig nach dem Rausch der Geschwindigkeit und gehst an Deine Grenzen. Die Straße ist Deine Heimat und Deine ganze Leidenschaft steckt im Rennradfahren, steile Pässe und ausdauernde Passagen zu bezwingen. Das unbeschreibliche Gefühl zu erleben, das Unmachbare doch geschafft zu haben! Exakt diese Einstellung treibt uns immer wieder an, für Dich neue Rennmaschinen zu entwickeln und in Raubling, im Herzen Bayerns fertigzustellen.

Are you addicted to the feeling of speed? Do you want to push your body to the next level in the saddle?. Road cycling is not just a sport for you, road cycling is pure passion and lifestyle. Steep climbs, or long climbs and fast downhills are your passion whilst cycling. The indescribable feeling of achieving impossible goals. With this passion and an eye for detail, corratec develops and produces road bikes for every purpose, in the heart of Upper Bavaria, in Raubling.

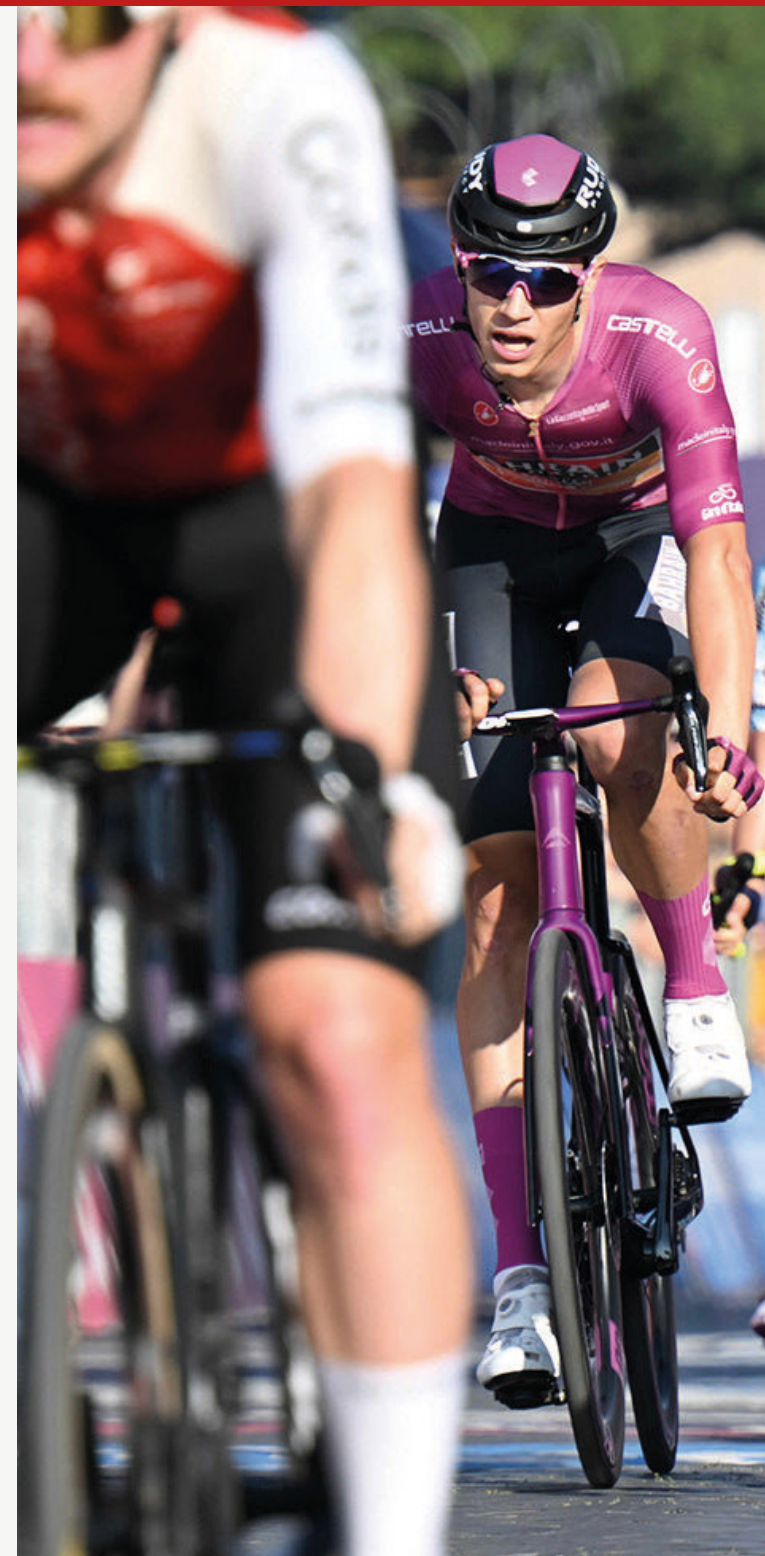



CCT EVO

800_{GR}

**Rahmengewicht ohne
Lackierung**

Frame weight without paint

AXS 12S

Kabelloses Schalten
Wireless shifting

30_{WATT}

**Ersparnis durch verbesserte
Aerodynamik**
Savings through improved
aerodynamics

FAST JUST GOT FASTER

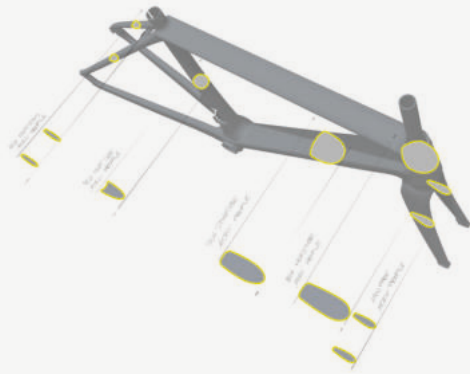

PERFEKTE AERODYNAMIK PERFECT AERODYNAMIC

Der Rahmen wurde an den nentralgischen Punkten, Gabel, Steuer- und Unterrohr, aerodynamisch auf Perfektion getrimmt. Das Ergebnis: Ein unglaublicher Vorteil von 30 Watt.

The frame was aerodynamically trimmed to perfection at the important points such as the fork, head tube and down tube. The result: an incredible advantage of 30 watts.

RACE COCKPIT

Rennfahren wie die Profis. Dank ergonomischer Lenkerdrops die speziell an die Taillierung der Daumen angepasst wurden, kannst du eine perfekte aerodynamische Position einnehmen und fühlst dich dabei noch pudelwohl. Eine Computer Mount ist integriert und fügt sich formschön in die Optik des Cockpits ein.

Race like the pros. Thanks to ergonomic handlebar drops that have been specially adapted to the crook of the thumbs, you can adopt a perfect aerodynamic position and still feel very comfortable. A computer mount is integrated and fits beautifully into the look of the cockpit.

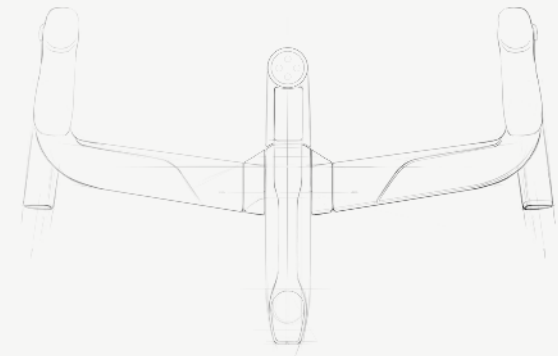

SPORTLICH & AGGRESSIV SPORTY & AGGRESSIVE

Das neue CCT EVO ist sportlich aggressiver unterwegs als sein Vorgänger. Dafür wurde der Faktor bzw. das Verhältnis zwischen Reach & Stack neu definiert. Der Reach ist länger und der Stack tiefer. Mit dieser sportlichen Sitzposition, die gleichzeitig auch komfortabel ist, gewinnst du zusätzliche 8 Watt.

The new CCT EVO is sportier and more aggressive than its predecessor. To achieve this, the factor or the relationship between reach and stack has been re-defined. The reach is longer and the stack lower. With this sporty seating position, which is also comfortable, you gain an additional 8 watts.

CCT EVO FACTORY

Ultraleichter und aerodynamischer „Bumerang Line“ voll Carbon Lenker und Rahmen. Ultralight and aerodynamic «Boomerang Line» full carbon handlebar and frame.

Integrierte Computer Mount für eine formschöne Optik im Cockpit. Integrated computer mount for a shapely look in the cockpit.

Elektronische Sram RED eTAP AXS Schaltgruppe für flüssige Schaltvorgänge. Electronic Sram RED eTAP switching group for fluid gear changes.



-  CCT EVO Carbon
-  corratec Road Pro Carbon Fork Disc
-  Sram RED ETAP AXS 12S
-  Sram RED ETAP AXS 2S
-  Sram RED ETAP AXS
-  Sram RED ETAP AXS 160mm | Front
-  Sram RED ETAP AXS 160mm | Rear
-  Sram RED D1 DUB 48/35T
-  Sram XG 1290 D1 10-33T
-  CN RED D1 12S
-  ZZYX 700C Carbon | Front
-  ZZYX 700C Carbon | Rear
-  PIRELLI P ZERO Race TLR | Front
-  PIRELLI P ZERO Race TLR | Rear
-  Selle Italia SLR Boost Superfl ow Carbon
-  ZZYX Carbon AERO Seatpost
-  ZZYX Road Stem Carbon Integrated
-  ZZYX Road Carbon Handlebar ICR

FARBE COLOR



Pearlized Black | Reflex Blue | Anodized White | Gold



Pearlized Black | Copper | Anodized White | Metallic Gray

BK29100

 46 | 48 | 51 | 54 | 57 | 60

VVP RRP 10.999 EUR

RAHMEN FRAME

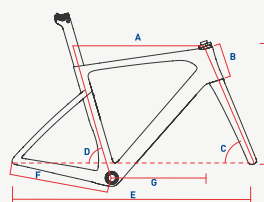

CCT EVO

CM	A	B	C	D	E	F	G	H
46	525	93	73	74	966	407	382	497
48	531	104	73	74	974	408	386	507
51	540	122	73	74	984	409	390	524
54	554	141	73	74	997	410	396	542
57	571	165	73	74	1013	411	404	565
60	588	193	73	74	1032	412	413	592

FEATURES

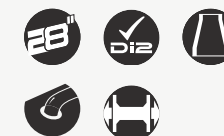

Bilder dienen nur als Veranschaulichung
Images are for illustrative purposes only

CCT EVO PRO

Ultraleichter und aerodynamischer „Bumerang Line“ voll Carbon Lenker und Rahmen. Ultralight and aerodynamic «Boomerang Line» full carbon handlebar and frame.

Integrierte Computer Mount für eine formschöne Optik im Cockpit. Integrated computer mount for a shapely look in the cockpit.

Elektronische Sram RED eTAP AXS Schaltgruppe für flüssige Schaltvorgänge. Electronic Sram RED eTAP switching group for fluid gear changes.

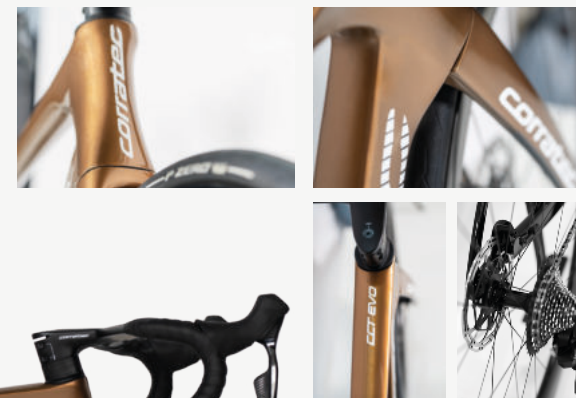

-  CCT EVO Carbon
-  corratec Road Pro Carbon Fork Disc
-  Sram RED ETAP AXS 12S
-  Sram RED ETAP AXS 2S
-  Sram RED ETAP AXS
-  Sram RED ETAP AXS 160mm | Front
-  Sram RED ETAP AXS 160mm | Rear
-  Sram RED D1 DUB 48/35T
-  Sram XG 1290 D1 10-33T
-  CN RED D1 12S
-  ZZYX 700C Carbon I Front
-  ZZYX 700C Carbon I Rear
-  PIRELLI P ZERO Race TLR I Front
-  PIRELLI P ZERO Race TLR I Rear
-  Selle Italia SLR Boost Superfl ow Carbon
-  ZZYX Carbon AERO Seatpost
-  ZZYX Road Stem Carbon Integrated
-  ZZYX Road Carbon Handlebar ICR
- ...

FARBE COLOR

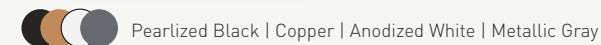
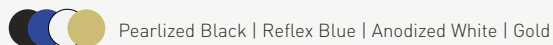

BK29101

 46 | 48 | 51 | 54 | 57 | 60

UVP RRP 6.999 EUR

RAHMEN FRAME

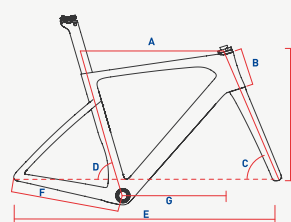

CCT EVO

CM	A	B	C	D	E	F	G	H
46	525	93	73	74	966	407	382	497
48	531	104	73	74	974	408	386	507
51	540	122	73	74	984	409	390	524
54	554	141	73	74	997	410	396	542
57	571	165	73	74	1013	411	404	565
60	588	193	73	74	1032	412	413	592

FEATURES

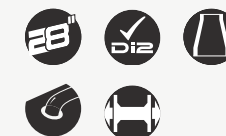

Bilder dienen nur als Veranschaulichung
Images are for illustrative purposes only

CCT EVO RACE

Ultraleichter und aerodynamischer „Boomerang Line“ voll Carbon Lenker und Rahmen. Ultralight and aerodynamic «Boomerang Line» full carbon handlebar and frame.

Integrierte Computer Mount für eine formschöne Optik im Cockpit. Integrated computer mount for a shapely look in the cockpit.

Elektronische Sram Rival eTAP Schaltgruppe für flüssige Gangwechsel. Electronic Sram Rival eTAP switching group for fluid gear changes.

-  CCT EVO Carbon
-  corratec Road Pro Carbon Fork Disc
-  Sram RIVAL ETAP AXS 12S
-  Sram RIVAL AXS 2S
-  Sram RIVAL AXS
-  Sram Rival AXS 160mm | Front
-  Sram Rival AXS 160mm | Front
-  Sram RIVAL DUB 46/33T
-  Shimano 10-SPD 11-32T
-  CN FORCE D1 12S
-  ZZYX Carbon 700C | Front
-  ZZYX Carbon 700C Irear
-  PIRELLI P ZERO Race TLR | Front
-  PIRELLI P ZERO Race TLR | Rear
-  Selle Italia Novus Boost Evo
-  ZZYX Carbon AERO Seatpost
-  ZZYX Road Stem Carbon Integrated
-  ZZYX Road Carbon Handlebar ICR



Das Rendering dient nur als Referenz
The Rendering is for Reference only

FARBE COLOR



Pearlized Black | Reflex Blue | Anodized White | Gold



Pearlized Black | Copper | Anodized White | Metallic Gray

BK29102

RAHMEN FRAME

CCT EVO

FEATURES

 46 | 48 | 51 | 54 | 57 | 60

VVP RRP **5.999 EUR**

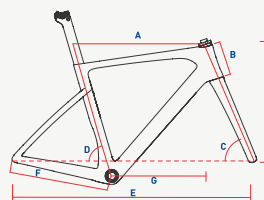

CM	A	B	C	D	E	F	G	H
46	525	93	73	74	966	407	382	497
48	531	104	73	74	974	408	386	507
51	540	122	73	74	984	409	390	524
54	554	141	73	74	997	410	396	542
57	571	165	73	74	1013	411	404	565
60	588	193	73	74	1032	412	413	592

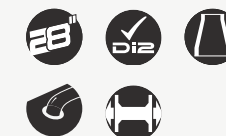

CCT TEAM PRO

Ultraleichter und aerodynamischer „Boomerang Line“ voll Carbon Lenker und Rahmen. Ultralight and aerodynamic «Boomerang Line» full carbon handlebar and frame.

Elektronische Shimano Di2 Schaltgruppe für flüssige Schaltvorgänge. Electronic Shimano Di2 switching group for fluid gear changes.

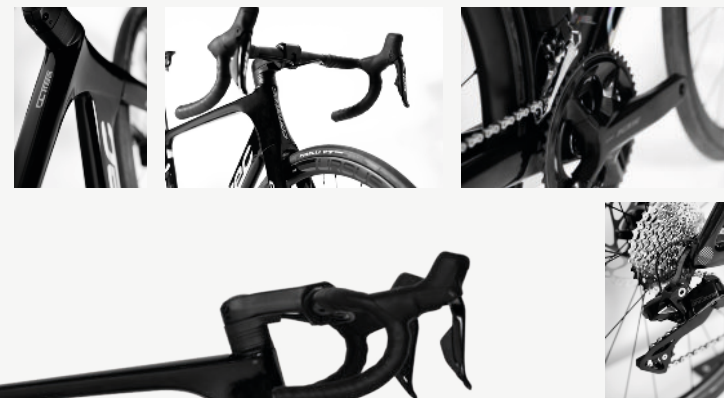

- CCT Team
- corratec Road Pro Carbon Fork Disc
- Shimano 105 Di2 12S
- Shimano 105 Di2 2S
- Shimano 105 Di2
- Shimano 105 160mm | Front
- Shimano 105 160mm | Rear
- Shimano 105 50-34T
- Shimano 105 12-SPEED 11-34T
- KMC X12
- URSUS MIURA | Front
- URSUS MIURA | Rear
- PIRELLI Pirelli P7 700C | Front
- PIRELLI Pirelli P7 700C | Rear
- Selle Italia Model X
- ZZYX Carbon Alloy Seatpost
- ZZYX Road Stem Alu ICR
- ZZYX Road Handlebar

FARBE COLOR

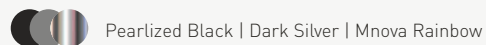

BK29110

46 | 48 | 51 | 54 | 57 | 60

UVP RRP 4.299 EUR

RAHMEN FRAME

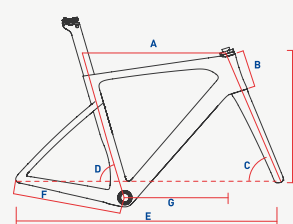

CCT TEAM

CM	A	B	C	D	E	F	G	H
46	525	93	73	74	966	407	382	497
48	531	104	73	74	974	408	386	507
51	540	122	73	74	984	409	390	524
54	554	141	73	74	997	410	396	542
57	571	165	73	74	1013	411	404	565
60	588	193	73	74	1032	412	413	592

FEATURES

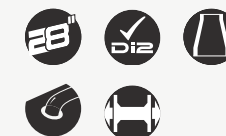

Bilder dienen nur als Veranschaulichung
Images are for illustrative purposes only

CCT TEAM ELITE

Ultraleichter und aerodynamischer „Boomerang Line“ voll Carbon Lenker und Rahmen. Ultralight and aerodynamic «Boomerang Line» full carbon handlebar and frame.

Ergonomischer Carbon-Lenker, damit Sie eine perfekte aerodynamische Position einnehmen können. Ergonomic Carbon handlebar, so you can adopt a perfect aerodynamik position.

Shimano Schaltgruppe für schnelle Gangwechsel. Shimano switching group for fluid gear changes.

-  CCT Team
-  corratec Road Pro Carbon Fork Disc
-  Shimano 105 Di2 12S
-  Shimano 105 2S
-  Shimano 105
-  Shimano 105 160mm | Front
-  Shimano 105 160mm | Rear
-  Shimano 105 50-34T
-  Shimano 105 12-SPEED 12-34T
-  KMC X12
-  MAVIC KSYRIUM | Front
-  MAVIC KSYRIUM | Rear
-  PIRELLI Pirelli P7 700C | Front
-  PIRELLI Pirelli P7 700C | Rear
-  Selle Italia Model X
-  ZZYX Alloy Steapost
-  ZZYX Road Stem Alu ICR
-  ZZYX Road Handlebar

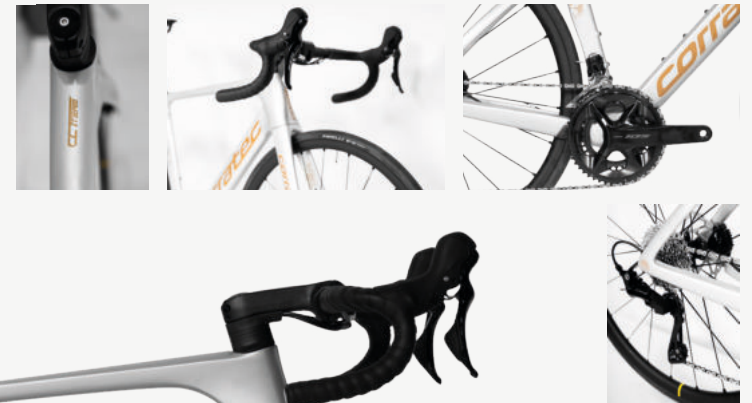

FARBE COLOR

 Rainbow Silver | Golden

BK29111

 46 | 48 | 51 | 54 | 57 | 60

UVP RRP **3.699 EUR**

RAHMEN FRAME

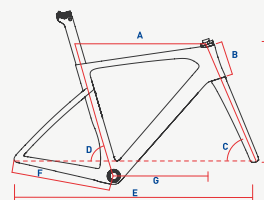

CCT TEAM

CM	A	B	C	D	E	F	G	H
46	525	93	73	74	966	407	382	497
48	531	104	73	74	974	408	386	507
51	540	122	73	74	984	409	390	524
54	554	141	73	74	997	410	396	542
57	571	165	73	74	1013	411	404	565
60	588	193	73	74	1032	412	413	592

FEATURES



Bilder dienen nur als Veranschaulichung
Images are for illustrative purposes only

CCT TEAM RACE

Ultraleichter und aerodynamischer „Boomerang Line“ voll Carbon Lenker und Rahmen. Ultralight and aerodynamic «Boomerang Line» full carbon handlebar and frame.

Elektronische Sram Rival eTAP Schaltgruppe für flüssige Schaltvorgänge. Electronic Sram Rival eTAP switching group for fluid gear changes.



-  CCT Team
-  corratec Road Pro Carbon Fork Disc
-  Shimano 105 11s
-  Shimano 105 2S
-  Shimano 105
-  Shimano 105 160mm | Front
-  Shimano 105 160mm | Rear
-  Shimano 105 50-34T
-  Shimano 105 12-SPEED 105 12S 11-34T
-  KMC X11
-  ALEX Rim 700C | Front
-  ALEX Rim 700C | Rear
-  PIRELLI Pirelli P7 700C | Front
-  PIRELLI Pirelli P7 700C | Rear
-  Monza full-fi t narrow Start
-  ZZZZX Alloy Steapost
-  ZZZZX Road Stem Alu ICR
-  ZZZZX Road Handlebar

FARBE COLOR

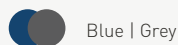

BK29112

RAHMEN FRAME

CCT TEAM

FEATURES

 46 | 48 | 51 | 54 | 57 | 60

UVP RRP 2.999 EUR

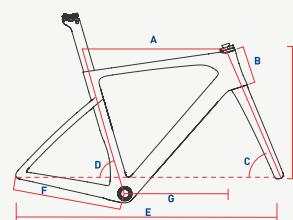

CM	A	B	C	D	E	F	G	H
46	525	93	73	74	966	407	382	497
48	531	104	73	74	974	408	386	507
51	540	122	73	74	984	409	390	524
54	554	141	73	74	997	410	396	542
57	571	165	73	74	1013	411	404	565
60	588	193	73	74	1032	412	413	592

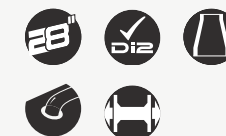

Das Rendering dient nur als Referenz
The Rendering is for Reference only

CORONES EXPERT DISC

Sportliche Geometrie für eine schnelle Feierabendrunde oder lange Trainingsfahrten. Sportive geometry – the one and only bike for fast and flat time trials.

Herausragende Technologien: PRO CONTROL DISC FORK und PRO SIZE 6 SYSTEM. Outstanding technologies: PRO CONTROL DISC FORK and PRO SIZE 6 SYSTEM.

Triple Butted Aluminium mit den Vorzügen einer Scheibenbremse. Triple Butted Aluminium frame with all the advantages of a disc brake.

-  Corones Disc
-  Road Carbon Fork Disc
-  Shimano 105 11s
-  Shimano 105
-  Shimano 105 11s
-  Shimano 105 160 mm I Front
-  Shimano 105 160 mm I Rear
-  Shimano FC-RS510 50 I 34T
-  Shimano 105 11-32T 11s
-  KMC X11
-  ZZYX 700C Disc I Front
-  ZZYX 700C Disc I Rear
-  Pirelli P7 700 x 26C I Front
-  Pirelli P7 700 x 26C I Rear
-  Selle San Marco Monza full fit narrow
-  ZZYX SL Alloy Seatpost 27.2mm
-  ZZYX SL Alloy Stem I ICR
-  ZZYX SL Alloy Handlebar



Das Rendering dient nur als Referenz
The Rendering is for Reference only

FARBE COLOR



Dark Metallic Blue | Pearlized White | Pearlized Black



Pearlized White | Silver

BK29120

RAHMEN FRAME

CORONES EXPERT DISC

FEATURES

 46 | 48 | 51 | 54 | 57 | 60

UVP RRP 1.999 EUR

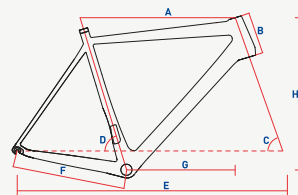

CM	A	B	C	D	E	F	G	H
46	524	108	71	74	976	410	378	510
48	531	118	72	74	976	410	381	522
51	541	135	73	74	987	413	386	539
54	553	152	73	74	997	413	391	555
57	567	173	73	74	1013	416	397	575
60	587	200	73	74	1033	416	409	601



DOLOMITI ELITE

Das Dolomiti verkörpert den Einstieg in die corratec Rennradwelt. The Dolomiti is perfect device for the first steps into the corratec roadbike family.

Robuster und leichter Aluminium Rahmen – der ideale Partner für das tägliche Training. Stable and light aluminium frame – fits perfectly for the daily training.

Herausragende Technologien: PRO CONTROL FORK und PRO SIZE 6 SYSTEM. Outstanding technologies: PRO CONTROL FORK and PRO SIZE 6 SYSTEM.



-  Dolomiti
-  Road Carbon Fork
-  Shimano 105 11s
-  Shimano 105
-  Shimano 105 11s
-  Tektro R741 Caliper Brake I Front
-  Tektro R741 Caliper Brake I Rear
-  Shimano FC-RS510 50 I 34T
-  Shimano 105 11-32T 11s
-  KMC X11
-  ZZYZX 700C Disc I Front
-  ZZYZX 700C Disc I Rear
-  Pirelli P7 700 x 26C I Front
-  Pirelli P7 700 x 26C I Rear
-  Selle San Marco Monza full fit narrow
-  ZZYZX SL Alloy Seatpost 27.2mm
-  ZZYZX SL Alloy Stem
-  ZZYZX SL Alloy Handlebar

FARBE COLOR

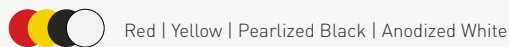

BK29130

 46 | 48 | 51 | 54 | 57 | 60

UVP RRP 2.999 EUR

RAHMEN FRAME

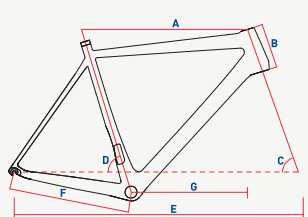

DOLOMITI ELITE

CM	A	B	C	D	E	F	G	H
46	505	125	71	75	963	407	360	524
48	522	135	73	74	961	407	367	539
51	530	150	73	74	957	407	365	556
54	547	160	73	73	969	407	374	566
57	572	175	73	73	991	407	392	580
60	588	195	73	73	1007	407	403	599

FEATURES



















Das Rendering dient nur als Referenz
The Rendering is for Reference only

C:TIME CONFI

Das C:Time – Der Sekundenjäger getrimmt auf Geschwindigkeit und Aerodynamik. The C: Time – The second hunter trimmed on speed and aerodynamics.

Sportliche Geometrie – das perfekte Bike für schnelle und flache Zeitfahren. Sportive geometry – the one and only bike for fast and flat time trials.

Hochprofil Carbon Laufräder für ein noch besseres Rollverhalten im Kampf gegen die Uhr. Aero carbon wheels for an even superior rolling behavior.

-  C:Time SL
-  Carbon Fork included in Frame
-  Sram Red eTAP AXS 12S
-  Sram BLIP
-  TRP T840 Caliper Brake
-  TRP T851 Caliper Brake
-  Sram Red DUB 48T
-  Sram XG1290 D1 10-33T 12S
-  Sram Red D1 12S
-  ZZYX TT Wheelset
-  Continental Grand Prix Attack III 700 x 23C I Front
-  Grand Prix Force III 700 x 25C I Rear
-  Selle San Marco Shortfit Dynamic
-  Seatpost included in Frame
-  ZZYX TT Stem
-  ZZYX TT Handlebar



Das Rendering dient nur als Referenz
The Rendering is for Reference only

FARBE COLOR auf Anfrage on request

BK29140

RAHMEN FRAME

C:TIME SL

FEATURES

 46 | 48 | 51 | 54 | 57

UVP RRP auf Anfrage on request

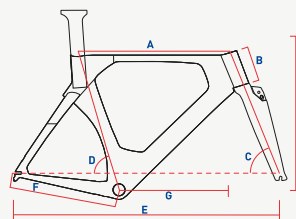

CM	A	B	C	D	E	F	G	H
46	492	80	73	76	929	387	372	479
48	519	80	73	76	954	387	399	480
51	542	107	73	76	978	387	415	506
54	565	134	73	76	1002	387	431	532
57	587	164	73	76	1027	387	447	558







THE GRAVELBIKE

Erlebe Dein Abenteuer in jedem Gelände. Raus aus dem Alltag und das einzigartige Feeling der Schotterpisten, Forststraßen oder Radwege genießen. Die corratec Allroad Range ist Dein idealer Begleiter für Deine Offroad Touren. Die speziell abgestimmte Radgeometrie und die verbauten Komponenten eignen sich perfekt für diesen Bereich.

Experience your adventure in any terrain. Get away from everyday life and enjoy the unique feeling of the gravel roads, forest roads or bike paths. The corratec Allroad Range is your companion for your offroad tours. The specially coordinated wheel geometry and the chosen components fits perfectly for this way of biking.





ALLROAD CARBON

40_{MM}

Reifenfreiheit
Tire clearance

12_{speed}

Kettenschaltung
Chain shifting

SHIMANO **GRX**
Di2

interne Kabelführung
Internal Cable Routing



LÄNGERER RADSTAND LONGER WHEELBASE

Dank des längeren Radstands und einer größeren Reifenfreiheit können problemlos bis zu 40mm breite Gravel Reifen montiert werden. Mit weniger Luftdruck bietet das Allroad Carbon somit mehr Komfort und erhöhte Pannensicherheit.

Thanks to the longer wheelbase and larger tire clearance, gravel tires up to 40mm wide can be fitted without any problems. With less air pressure, the Allroad Carbon offers more comfort and increased puncture resistance.

GEPÄCKTRÄGERAUFNAHMEN LUGGAGE CARRIER MOUNTS

Gabel und Hinterbau sind mit Gepäckträgeraufnahmen ausgestattet. Es können somit bequem und jederzeit bis zu zwei Gepäckträger montiert werden.

The fork and rear end are equipped with rack mounts. This means that up to two luggage racks can be mounted conveniently and at any time.



SHIMANO GRX Di2

Die neue gravel Schaltgruppe begeistert mit einer auf Schotter abgestimmten Halterungsergonomie und optimierten Schaltoptionen. Eine durchdachte Lösung für alle, die im Sattel die Welt entdecken möchten.

The all new Gravel groupset impresses with its mounting ergonomics tailored to gravel and optimized gearshift options - a well thought-out solution for everyone who wants to explore the world on two wheels.



ALLROAD C1

Gepäckträger an der Gabel und am Heck, um jederzeit bereit für ein großes Abenteuer. Luggage Carrier on the fork and at the rear to be ready at all time for a huge adventure.

Passt perfekt als Pendlerad für tägliche Fahrten. Fits perfectly as a commuter for daily rides.

Endurance Geometry mit sportlichem aerodynamischem Design. Endurance Geometry with a sportive aerodynamic design.



ALLROAD

- Allroad Carbon
- corratec Allroad Pro Carbon Fork
- Sram X1 Eagle AXS 12s
- Sram Apex Eagle AXS 12s
- Sram Apex 160 mm | Front
- Sram Apex 160 mm | Rear
- Sram Apex Wide 42T
- Sram XG 1275 Eagle 10-52T
- CN GX Eagle
- URSUS MIURA 700C
- URSUS MIURA 700C
- Schwalbe G-ONE Allroun Perf. 700c-45 | Front
- Schwalbe G-ONE Allroun Perf. 700c-45 | Rear
- Selle Italia Model X
- Included in Frame
- ZZYX Alloy Stem
- ZZYX Allroad Carbon Handlebar

FARBE COLOR



Bizzare Green | Black | Dark Blue | Cool Gray

BK29160

47 | 49 | 52 | 54 | 56 | 58

UVP RRP **4.499 €**

RAHMEN FRAME

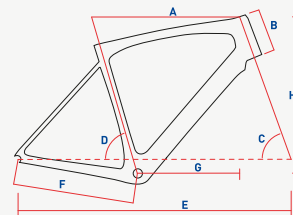

ALLROAD CARBON

CM	A	B	C	D	E	F	G	H
47	495	95	70	75	1015	440	356	523
49	505	111	70	74	1014	440	356	537
52	526	136	70	74	1032	440	365	561
54	546	156	71	74	1038	440	373	584
56	570	176	71	73	1058	440	386	603
58	591	196	71	73	1079	440	401	621

FEATURES

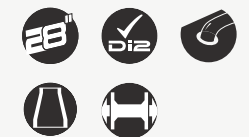

Bilder dienen nur als Veranschaulichung
Images are for illustrative purposes only

ALLROAD C2

Gepäckträger an der Gabel und am Heck, um jederzeit bereitfür ein großes Abenteuer. Luggage Carrier on the fork and at the rear to be ready at all time for a huge adventure.

Passt perfekt als Pendlerad für tägliche Fahrten. Fits perfectly as a commuter for daily rides.

Endurance Geometry mit sportlichem aerodynamischem Design. Endurance Geometry with a sportive aerodynamic design.

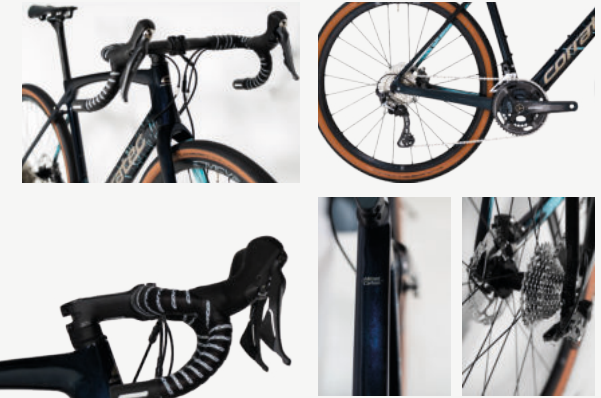

- Allroad Carbon
- corratec Allroad Pro Carbon Fork
- Shimano GRX 12s
- Shimano GRX 12s // Shimano GRX 2s
- Shimano GRX 160 mm | Front
- Shimano GRX 160 mm | Rear
- Shimano GRX 172.5 mm 48T - 31T
- SHIMANO HG710 12s 11-36T
- KMC X12 Silver/Black
- Zyx Rim 700C | Front
- Zyx Rim 700C | Rear
- Schwalbe G-ONE Allround Perf. 700c x 45 | Front
- Schwalbe G-ONE Allround Perf. 700c x 45 | Rear
- Selle Italia Model X
- Included in Frame
- ZZYX Alloy Stem
- ZZYX Allroad Handlebar

FARBE COLOR

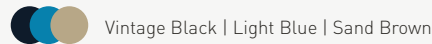

BK29161

47 | 49 | 52 | 54 | 56 | 58

UVP RRP 2.999 €

RAHMEN FRAME

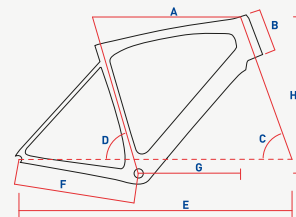

ALLROAD CARBON

CM	A	B	C	D	E	F	G	H
47	495	95	70	75	1015	440	356	523
49	505	111	70	74	1014	440	356	537
52	526	136	70	74	1032	440	365	561
54	546	156	71	74	1038	440	373	584
56	570	176	71	73	1058	440	386	603
58	591	196	71	73	1079	440	401	621

FEATURES



Bilder dienen nur als Veranschaulichung
Images are for illustrative purposes only



ALLROAD C EKAR

Gepäckträger an der Gabel und am Heck, um jederzeit bereit für ein großes Abenteuer. Luggage Carrier on the fork and at the rear to be ready at all time for a huge adventure.

Passt perfekt als Pendlerad für tägliche Fahrten. Fits perfectly as a commuter for daily rides.

Campagnolo Ekar Gravel-Antrieb mit großer Bandbreite, enger Übersetzung und ohne Kompromisse. Campagnolo Ekar gravel drivetrain with wide bandwidth, close gearing and no compromises.



- Allroad Carbon
- corratec Allroad Pro Carbon Fork
- Campagnolo Ekar 13-speed
- Campagnolo Ekar 13-speed
- Campagnolo Ekar 160 mm | Front
- Campagnolo Ekar 160 mm | Rear
- Campagnolo Ekar 42T
- Campagnolo Ekar 13-speed 9-42T
- Campagnolo Ekar 13-speed
- Mavic Allroad S Disc CL
- Mavic Allroad S Disc CL
- WTB, Riddler 700Cx45 TCS | Front
- WTB, Riddler 700Cx45 TCS | Rear
- Selle Italia Model X
- Included in Frame
- ZZYX Alloy Stem
- ZZYX Allroad Carbon Handlebar

FARBE COLOR

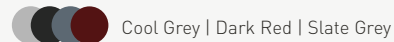

BK29162

RAHMEN FRAME

ALLROAD

FEATURES

47 | 49 | 52 | 54 | 56 | 58

UVP RRP **3.999 €**

CM	A	B	C	D	E	F	G	H
47	495	95	70	75	1015	440	356	523
49	505	111	70	74	1014	440	356	537
52	526	136	70	74	1032	440	365	561
54	546	156	71	74	1038	440	373	584
56	570	176	71	73	1058	440	386	603
58	591	196	71	73	1079	440	401	621

Das Rendering dient nur als Referenz
The Rendering is for Reference only





ALLROAD A1

Mit dem neuen Facelift werden neidische Blicke auf die spektakulärsten Schotterpisten der Welt gewährt. With the new face lift jealous views are granted at worlds most spectacular gravel roads.

Gepäckträgerhalterungen vorne und hinten - seien Sie bereit für das große Abenteuer. Gepäckträgerhalterungen vorne und hinten - seien Sie bereit für das große Abenteuer.

Passt perfekt zum Pendeln oder als tägliches Trainingsgerät besonders im Frühjahr und Herbst. Fits perfectly for commuting or as daily training device especially in spring and autumn.

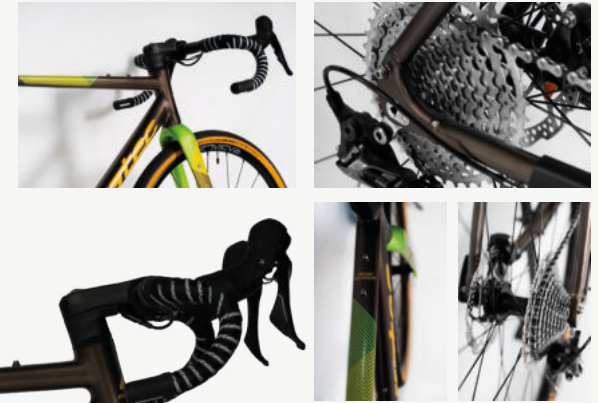

ALLROAD

- Allroad
- corratec Allroad Pro Carbon Fork
- Shimano GRX 12Ss
- Shimano GRX
- Shimano GRX 160mm I Front
- Shimano GRX 160mm I Rear
- Shimano GRX 40T
- Shimano Deore 12-s 11-51T
- KMC X12
- Zzyzx Rim 700C I Front
- Zzyzx Rim 700C I Rear
- Schwalbe G-One Allroad 700C x 40 I Front
- Schwalbe G-One Allroad 700C x 40 I Rear
- Selle Italia X3 Black
- ZZYZX Alloy Steapost
- ZZYZX Road Stem Alu
- ZZYZX Allroad Handlebar

FARBE COLOR

Brown | Light Green | Sand

BK29170

RAHMEN FRAME

ALLROAD

FEATURES

46 | 49 | 52 | 55 | 58 | 61

UVP RRP **2.199 €**

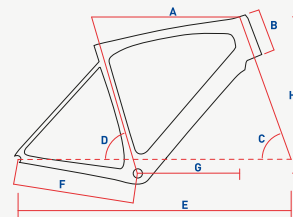

CM	A	B	C	D	E	F	G	H
46	526	115	71	74	1012	430	372	536
49	532	124	71	74	1014	430	375	546
52	540	138	71	74	1024	430	380	559
55	551	155	71	74	1035	430	386	575
58	572	180	71	74	1052	430	395	599
61	597	210	71	73	1072	430	405	627



Bilder dienen nur als Veranschaulichung
Images are for illustrative purposes only

ALLROAD A2

Mit dem neuen Facelift werden neidische Blicke auf die spektakulärsten Schotterpisten der Welt gewährt. With the new face lift jealous views are granted at worlds most spectacular gravel roads.

Gepäckträgerhalterungen vorne und hinten - seien Sie bereit für das große Abenteuer. Gepäckträgerhalterungen vorne und hinten - seien Sie bereit für das große Abenteuer.

Passt perfekt zum Pendeln oder als tägliches Trainingsgerät besonders im Frühjahr und Herbst. Fits perfectly for commuting or as daily training device especially in spring and autumn.

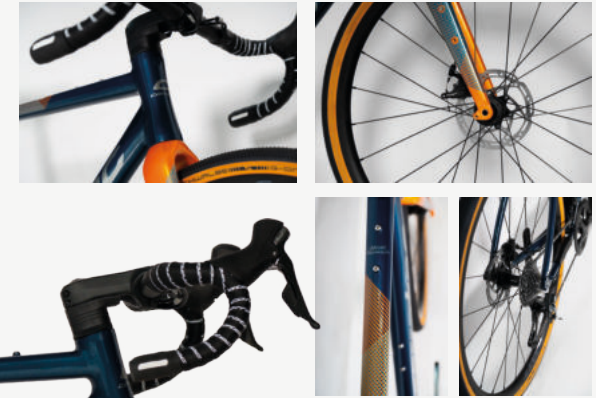

ALLROAD

- Allroad
- corratec Allroad Pro Carbon Fork
- Shimano Tiagra GS 10s
- Shimano Tiagra FD 4700
- Shimano Tiagra 2 x 10s
- Tektro Spyre 160mm | Front
- Tektro Spyre 160mm | Rear
- Shimano Crank 46T | 34T
- Shimano HG-50 10s 11-32T
- KMC X10
- Zyzx Rim 700C | Front
- Zyzx Rim 700C | Rear
- Schwalbe G-One Allroad 700C x 40 | Front
- Schwalbe G-One Allroad 700C x 40 | Rear
- Selle Italia X3 Black
- ZYZX Alloy Steapost
- ZYZX Road Stem Alu
- ZYZX Allroad Handlebar

FARBE COLOR



Petrol | Copper Orange | Turquoise | Silver Gray

BK29171

RAHMEN FRAME

ALLROAD

FEATURES

46 | 49 | 52 | 55 | 58 | 61

UVP RRP 1.699 €

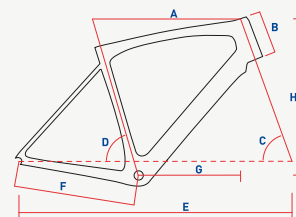

CM	A	B	C	D	E	F	G	H
46	526	115	71	74	1012	430	372	536
49	532	124	71	74	1014	430	375	546
52	540	138	71	74	1024	430	380	559
55	551	155	71	74	1035	430	386	575
58	572	180	71	74	1052	430	395	599
61	597	210	71	73	1072	430	405	627



Bilder dienen nur als Veranschaulichung
Images are for illustrative purposes only



THE TRAVELBIKE

Erlebe Dein Abenteuer in jedem Gelände. Raus aus dem Alltag und das einzigartige Feeling der Schotterpisten, Forststraßen oder Radwege genießen. Die corratec Allroad Range ist Dein idealer Begleiter für Deine Offroad Touren. Die speziell abgestimmte Radgeometrie und die verbauten Komponenten eignen sich perfekt für diesen Bereich.

Experience your adventure in any terrain. Get away from everyday life and enjoy the unique feeling of the gravel roads, forest roads or bike paths. The corratec Allroad Range is your companion for your offroad tours. The specially coordinated wheel geometry and the chosen components fits perfectly for this way of biking.





ALLROAD TRAVEL

50_{MM}

Reifenfreiheit
Tire clearance

12_{speed}

Kettenschaltung
Chain shifting

BOW
SITZSTREBE

Für maximalen Komfort
For maximum comfort





LÄNGERER RADSTAND LONGER WHEELBASE

Dank des längeren Radstands und einer größeren Reifenfreiheit können problemlos bis zu 40mm breite Gravel Reifen montiert werden. Mit weniger Luftdruck bietet das Allroad Carbon somit mehr Komfort und erhöhte Pannensicherheit.

Thanks to the longer wheelbase and larger tire clearance, gravel tires up to 40mm wide can be fitted without any problems. With less air pressure, the Allroad Carbon offers more comfort and increased puncture resistance.

GEPÄCKTRÄGERAUFNAHMEN LUGGAGE CARRIER MOUNTS

Gabel und Hinterbau sind mit Gepäckträgeraufnahmen ausgestattet. Es können somit bequem und jederzeit bis zu zwei Gepäckträger montiert werden.

The fork and rear end are equipped with rack mounts. This means that up to two luggage racks can be mounted conveniently and at any time.



SHIMANO GRX

Die neue Gravel Schaltgruppe begeistert mit einer auf Schotter abgestimmten Halterungsergonomie und optimierten Schaltoptionen. Eine durchdachte Lösung für alle, die im Sattel die Welt entdecken möchten.

The all new Gravel groupset impresses with its mounting ergonomics tailored to gravel and optimized gearshift options - a well thought-out solution for everyone who wants to explore the world on two wheels.



ALLROAD TRAVEL 1

Das sehr stabile Allroad ist der ideale Partner für Deine Bikepacking Touren und Expeditionen. The very stable Allroad is your perfect partner for your bikepacking tours and expeditions.

Die speziell vormontierten Gepäckträgeraufnahmen stellen Dir ausreichend Platz für Packtaschen zur Verfügung. The specially pre-assembled luggage rack mounts provide you with sufficient space for panniers.

Der stabile Alurahmen bietet Dir ausreichend Sicherheit im Gelände. The stable aluminum frame offers you sufficient safety in the field.



ALLROAD

- Allroad Travel
- Allroad Alloy Fork
- Shimano GRX 10S
- Shimano GRX 10S
- Shimano GRX 160mm I Front
- Shimano GRX 160mm I Rear
- Shimano GRX 46 I 30T
- Shimano CS-HG50 11-36T 10S
- KMC X10
- ZZYZX 700C Disc I Front
- ZZYZX 700C Disc I Rear
- Schwalbe G-One Bite Perf. 50-622 I Front
- Schwalbe G-One Bite Perf. 50-622 I Rear
- Selle Italia X3
- ZZYZX Suspension Seatpost 27.2mm
- Redshift Shockstop suspension stem
- ZZYZX Gravel Riser

FARBE COLOR



Orange Red | Pearlized Black | Dark Red

BK29180

RAHMEN FRAME

ALLROAD TRAVEL

FEATURES

46 | 49 | 52 | 55 | 58 | 61

UVP RRP **1.899 €**

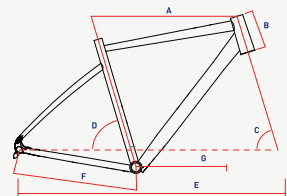

CM	A	B	C	D	E	F	G	H
46	542	115	71	74	1057	460	382	558
49	551	129	72	74	1062	460	387	573
52	561	145	72	74	1073	460	392	588
55	570	161	72	74	1083	460	397	603
58	580	178	72	74	1093	460	402	619
61	589	194	72	74	1103	460	407	635



Bilder dienen nur als Veranschaulichung
Images are for illustrative purposes only

ALLROAD TRAVEL 2

Das sehr stabile Allroad ist der ideale Partner für Deine Bikepacking Touren und Expeditionen. The very stable Allroad is your perfect partner for your bikepacking tours and expeditions..

Die speziell vormontierten Gepäckträgeraufnahmen stellen Dir ausreichend Platz für Packtaschen zur Verfügung. The specially pre-assembled luggage rack mounts provide you with sufficient space for panniers

Der stabile Alurahmen bietet Dir ausreichend Sicherheit im Gelände. The stable aluminum frame offers you sufficient safety in the field.



- Allroad Travel
- Allroad Alloy Fork
- Shimano Claris 8S
- Shimano Claris 8S
- Tektro Spyre 160mm I Front
- Tektro Spyre 160mm I Rear
- Shimano Claris 50 I 34T
- Shimano CS-HG50 11-34T 8S
- KMC X8
- ZYZX 700C Disc I Front
- ZYZX 700C Disc I Rear
- Schwalbe G-One Bite Perf. 50-622 I Front
- Schwalbe G-One Bite Perf. 50-622 I Rear
- Selle Italia X3
- ZYZX Suspension Seatpost 27.2mm
- Redshift Shockstop suspension stem
- ZYZX Gravel Riser

FARBE COLOR



BK29181

46 | 49 | 52 | 55 | 58 | 61

UVP RRP 1.499 €

RAHMEN FRAME

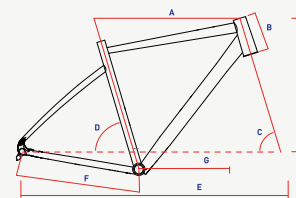

ALLROAD TRAVEL

CM	A	B	C	D	E	F	G	H
46	542	115	71	74	1057	460	382	558
49	551	129	72	74	1062	460	387	573
52	561	145	72	74	1073	460	392	588
55	570	161	72	74	1083	460	397	603
58	580	178	72	74	1093	460	402	619
61	589	194	72	74	1103	460	407	635

FEATURES



Das Rendering dient nur als Referenz
The Rendering is for Reference only



THE MOUNTAINBIKE

Unsere Mountainbikes sind auf den Straßen, im Gelände und am Berg zu Hause – und das mit großem Erfolg. Die Herausforderung für uns ist es, den Ansprüchen an Design und Technik gerecht zu werden! Seit Jahrzehnten arbeiten wir an dem perfekten Mountainbike, denn für jeden gibt es das perfekte Fahrrad! Für Simon Gegenheimer ist es das Revo Bow.

Our mountain bikes perform on the roads, off-road and on the mountain – and this with great success. The main challenge for us is to satisfy the demands of design and technology – since day one! We have been working on the perfect mountain bike for world-class level for decades, because for everyone there is the perfect bike! For Simon Gegenheimer it is the Revo Bow.





REVOLUTION iLINK SL FACTORY

2000_{GR}

Rahmengewicht inkl.
Dämpfer
Frame weight incl. Damper

520%

Übersetzungsbandbreite
Transmission bandwidth

100_{MM}

Rockshox SID Ultimate Gabel
Rockshox SID Ultimate Fork





VIRTUELLER DREHPUNKT VIRTUAL PIVOT POINT

200% ANTI SQUAD VERTICAL FLEX



















AUTOMATISCHER LOCKOUT AUTOMATIC LOCKOUT

REVOLUTION iLINK SL FACTORY

Superleichter Rahmen mit einem Gewicht inklusive Dämpfer unter 2000gr und einer sehr hohen Torsionssteifigkeit. Superlight frame with a weight including damper under 2000gr and a very high torsional stiffness.

iLink TECHNOLOGY - das hintere Dreieck ohne ohne separaten Lockout erreicht maximalen Vortrieb. SiLink TECHNOLOGY – the rear triangle without a separate lockout achieves maximum propulsion.

Hochwertige Komponenten garantieren beste Performance auf allen Trails. High-quality components ensures best performance on all trails.

-  Revolution iLink SL
-  Rockshox SID Ultimate Remote 29" 100mm
-  Rockshox SID Luxe Ultimate RL 190 x 40
-  Sram XX1 Eagle AXS 12S
-  Sram AXS Eagle 12S
-  Sram Level Ultimate Carbon 180mm | Front
-  Sram Level Ultimate Carbon 160mm | Rear
-  Sram XX1 Eagle DUB 175mm 32T
-  Sram XG1299 Eagle 10-52T 12S
-  Sram XX1 Eagle Rainbow 12S
-  DT Swiss XRC 1200 Spline 29" | Front
-  DT Swiss XRC 1200 Spline 29" | Rear
-  Schwalbe Racing Ray 60-622 | Front
-  Schwalbe Racing Ralph 60-622 | Rear
-  Selle Italia Flite Boost Superflow Carbon
-  Rockshox Reverb AXS 31.6mm
-  ZZYX SL Alloy Stem
-  ZZYX SL Carbon Handlebar



Das Rendering dient nur als Referenz
The Rendering is for Reference only

FARBE COLOR

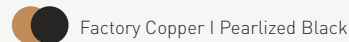

BK29000

RAHMEN FRAME

REVOLUTION iLINK SL

FEATURES

 44 | 48 | 52

VVP RRP 10.999 EUR

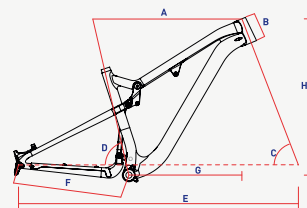

CM	A	B	C	D	E	F	G	H
44	589	101	68	72	1146	435	435	610
48	616	106	68	72	1173	435	460	615
52	640	122	68	72	1198	435	479	632



REVOLUTION iLINK SL PRO TEAM

120 mm Federweg für überragenden Fahrspaß auf technischen Trails. 120 mm suspension travel for superior riding pleasure on technical trails.

iLink TECHNOLOGY - der Hinterbau ohne ohne separates Lockout sorgt für maximalen Vortrieb. iLink TECHNOLOGY - the rear triangle without a separate lockout achieves maximum propulsion.

Flacherer Lenkkopfwinkel sorgt für mehr Komfort auf Allmountain-Touren. Flatter steering head angle ensures more comfort on Allmountain tours.



- Revolution iLink SL
- Rockshox SID Select+ RL Remote 29" 120mm
- Rockshox Deluxe Select+ RT 190 x 45
- Sram X01 Eagle 12S
- Sram GX Eagle 12S
- Sram G2 180mm I Front
- Sram G2 160mm I Rear
- Sram X1 Eagle DUB 175mm 32T
- Sram XG1295 Eagle 10-52T 12S
- Sram GX Eagle 12S Grey
- DT Swiss XM 1700 Spline 29" I Front
- DT Swiss XM 1700 Spline 29" I Rear
- Schwalbe Racing Ray 60-622 I Front
- Schwalbe Racing Ralph 60-622 I Rear
- Selle Italia Flite Boost Superflow Manganese
- Kindshock LEV Integra 31.6mm
- ZYZX SL Alloy Stem
- ZYZX SL Carbon Handlebar

FARBE COLOR

Factory Copper | Pearlized Black

BK29001

RAHMEN FRAME

REVOLUTION iLINK SL

FEATURES

44 | 48 | 52

UVP RRP 6.499 EUR

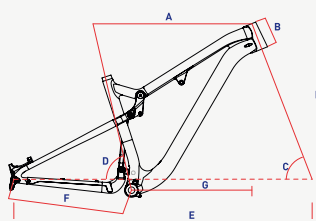

CM	A	B	C	D	E	F	G	H
44	589	101	68	72	1146	435	435	610
48	616	106	68	72	1173	435	460	615
52	640	122	68	72	1198	435	479	632



Das Rendering dient nur als Referenz
The Rendering is for Reference only

REVOLUTION iLINK PRO

Das perfekte Bike für Allmountain-Touren und flowige Trails. The perfect bike for allmountain tours and flowy trails.

iLink TECHNOLOGY - der Hinterbau ohne Hinterbau ohne separates Lockout sorgt für maximalen Vortrieb. iLink TECHNOLOGY - the rear triangle without a separate lockout achieves maximum propulsion.

Das nach dem Boost-Standard entwickelte Bike, erzeugt maximale Agilität im Gelände. The bike, developed according to the Boost standard, generates maximum agility off-road.

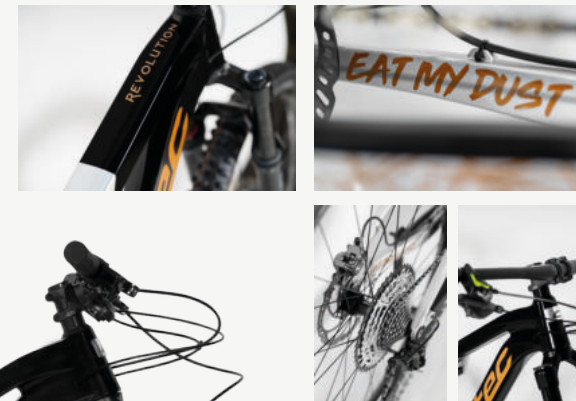

-  Revolution iLink
-  Rockshox SID Select RL 29" 120mm
-  Rockshox Deluxe Select+ RT 190 x 45
-  Shimano Deore XT SGS 12S
-  Shimano Deore XT 12S
-  Shimano Deore XT M8120 180mm I Front
-  Shimano Deore XT M8100 160mm I Rear
-  Shimano Deore XT 175mm 32T
-  Shimano SLX 10-51T 12S
-  KMC X12
-  DT Swiss M 1900 Spline 29" Tubeless Ready I Front
-  DT Swiss M 1900 Spline 29" Tubeless Ready I Rear
-  Schwalbe Hans Dampf 60-622 I Front
-  Schwalbe Hans Dampf 60-622 I Rear
-  Selle Italia Model X
-  Kindshock Ragei 31.6mm
-  ZZYX SL Alloy Stem
-  ZZYX SL Alloy Handlebar

FARBE COLOR

 Pearlized Black | Rainbow Silver | Golden

BK29002

RAHMEN FRAME

REVOLUTION iLINK

FEATURES

 44 | 48 | 52

UVP RRP **4.499 EUR**

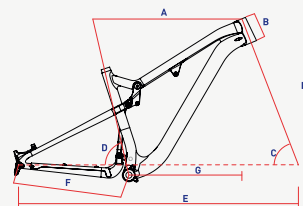

CM	A	B	C	D	E	F	G	H
44	589	101	68	72	1146	435	435	610
48	616	106	68	72	1173	435	460	615
52	640	122	68	72	1198	435	479	632



Bilder dienen nur als Veranschaulichung
Images are for illustrative purposes only

REVOLUTION iLINK ELITE

Das perfekte Bike für Allmountain-Touren und flowige Trails. The perfect bike for allmountain tours and flowy trails.

Hinterbau ohne separates Lockout sorgt für maximalen Vortrieb. Rear triangle without separate lockout ensures maximum propulsion.

Das nach dem Boost-Standard entwickelte Bike, erzeugt maximale Agilität im Gelände. The bike, developed according to the Boost standard, generates maximum agility off-road.

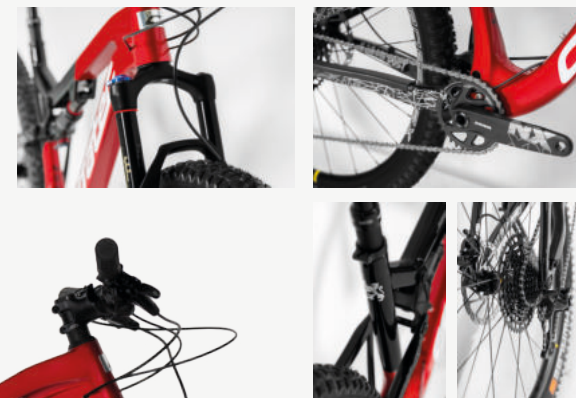

- Revolution iLink SL
- Rockshox SID Select+ RL Remote 29" 120mm
- Rockshox Deluxe Select+ RT 190 x 45
- Sram X01 Eagle 12S
- Sram GX Eagle 12S
- Sram G2 180mm | Front
- Sram G2 160mm | Rear
- Sram X1 Eagle DUB 175mm 32T
- Sram XG1295 Eagle 10-52T 12S
- Sram GX Eagle 12S Grey
- DT Swiss XM 1700 Spline 29" | Front
- DT Swiss XM 1700 Spline 29" | Rear
- Schwalbe Racing Ray 60-622 | Front
- Schwalbe Racing Ralph 60-622 | Rear
- Selle Italia Flite Boost Superflow Manganese
- Kindshock LEV Integra 31.6mm
- ZZYX SL Alloy Stem
- ZZYX SL Carbon Handlebar

FARBE COLOR



BK29003

RAHMEN FRAME

REVOLUTION iLINK

FEATURES

44 | 48 | 52

UVP RRP 3.899 EUR

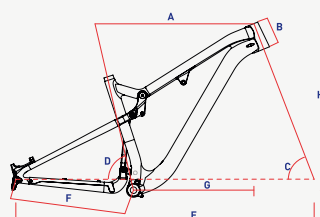

CM	A	B	C	D	E	F	G	H
44	589	101	68	72	1146	435	435	610
48	616	106	68	72	1173	435	460	615
52	640	122	68	72	1198	435	479	632



Bilder dienen nur als Veranschaulichung
Images are for illustrative purposes only

REVO BOW SL FACTORY

948_{GR}

RAHMENGEWICHT
FRAME WEIGHT

AXS
12S

Kabelloses Schalten
Wireless shifting

100_{MM}

Rockshox SID Ultimate Gabel
Rockshox SID Ultimate Fork

**MOUNTAINBIKERIN MARION FROMBERGER IST
DEUTSCHE MEISTERIN MTB ELIMINATOR
MOUNTAIN BIKER MARION FROMBERGER IS
GERMAN MTB ELIMINATOR CHAMPION**



MAXIMALE KRAFTÜBERTRAGUNG MAXIMUM POWER TRANSMISSION

Die Rahmenform „Bow“ wird zu 100% im Hause corrateg konstruiert und entwickelt. Diese Rahmenform bietet Dir maximale Verwindungssteifigkeit und erzeugt größtmögliche Traktion und Kontrolle in jedem Gelände.

This unique innovation, 100% designed and developed by corrateg, offers you maximum torsional rigidity of the frame and thus generates the greatest possible traction and control in any terrain.

VERTIKALER FLEX VERTICAL FLEX

Eine weitere herausragende Innovation von corrateg ist das neuentwickelte Sattelrohr des Revo Bow. Diese Weiterentwicklung bietet Dir durch seine breitere Form ein neues Maß an Dämpfungseigenschaften.

Another outstanding innovation from corrateg is the newly developed seat tube of the Revo Bow. This further development offers you a new level of damping properties thanks to its wider shape.



EINZIGARTIGES DESIGN UNIQUE DESIGN

Das Design des neuen Revo Bow ist ein absolutes Highlight. Diese besondere Perlmutter-Lackierung garantiert maximale Aufmerksamkeit während der Fahrt und auf der Alm.

The design of the new Revo Bow is an absolute highlight. With its different color effects, this extravagant mother-of-pearl finish ensures you maximum attention during your ride and on the alpine pasture.

REVO BOW SL FACTORY

Das einzigartige Bogendesign besticht durch eine hohe Torsionssteifigkeit für maximale Kontrolle. The unique bow design impresses with a high degree of torsional rigidity for maximum control.

Die interne Kabelführung verleiht dem Bike einen cleanen Look. Internal Cable Routing give the bike a clean look.

Technisch rundet die elektronische Sram T-Type AXS Schaltung rundet das gesamte System ab. Technically, the Sram T-Type AXS electronic gearshift rounds off the entire system.



- 🚲 Revo BOW SL
- 🏹 RockShox SID SL Ultimate Remote 29" 100MM
- 🔗 SRAM XX SL EAGLE AXS T-TYPE 12-SPEED
- 🔗 SRAM AXS POD ULTIMATE
- ⚙️ SRAM LEVEL ULTIMATE STEALTH 2-Piston 180mm | Front
- ⚙️ SRAM LEVEL ULTIMATE STEALTH 2-Piston 160mm | Rear
- 🔗 SRAM XX SL EAGLE DUB 170 34T T-TYPET
- 🔗 SRAM CS XS 1299 T-TYPE 10-52
- 🔗 SRAM XX SL T-TYPE 116 LINK
- 🌀 DT Swiss XCR 1200 Spline® 29" | Front
- 🌀 DT Swiss XCR 1200 Spline® 29" | Rear
- 🌀 Schwalbe RACING RAY Evo 29" | Front
- 🌀 Schwalbe RACING RALPH Evo 29" | Rear
- 🪑 Selle Italia Flite Boost Superflow Carbon
- 🏹 ZYZX Carbon Seatpost
- 🏹 ZYZX Alloy Stem
- 🏹 ZYZX Mountain Carbon Handlebar

FARBE COLOR

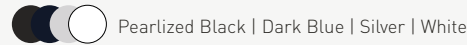

BK29010

RAHMEN FRAME

REVO BOW SL

FEATURES

👤 39 | 44 | 49 | 54

VVP RRP 8.999 EUR

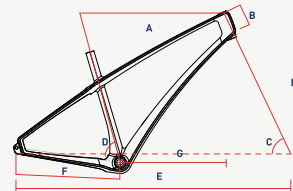

CM	A	B	C	D	E	F	G	H
39	580	95	69	72	1091	425	407	605
44	600	100	69	72	1111	425	425	610
49	625	110	69	72	1137	425	447	619
54	650	121	69	72	1162	425	469	630



Bilder dienen nur als Veranschaulichung
Images are for illustrative purposes only

















REVO BOW SL PRO TEAM

Das einzigartige Bogendesign besticht durch eine hohe Torsionssteifigkeit für maximale Kontrolle. The unique bow design impresses with a high degree of torsional rigidity for maximum control.

Aufgeräumtes Cockpit mit komplett innenliegenden Zügen. Tidy cockpit with completely internal cables.

Der edle Carbonrahmen bietet beste Dämpfungseigenschaften auf langen Tagestouren. The noble carbon frame offers the best damping properties on long day trips.



-  Revo BOW SL
-  FS SID SL SELECT+ 3 POS 29" 100MM
-  SRAM X0 EAGLE AXS T-TYPE 12-SPEED
-  SRAM AXS POD
-  SRAM LEVEL BRONZE STEALTH 2-Piston 180mm | Front
-  SRAM LEVEL BRONZE STEALTH 2-Piston 160mm | Rear
-  SRAM XX EAGLE DUB 170 34T T-TYPE
-  SRAM CS XS 1275 T-TYPE 10-52
-  SRAM GXT-TYPE 116 LINK
-  DT Swiss XMC 1501 Spline@ 29" | Front
-  DT Swiss XMC 1501 Spline@ 29" | Rear
-  Schwalbe RACING RAY Evo 29" | Front
-  Schwalbe RACING RALPH Evo 29" | Rear
-  Selle Italia Flite Boost Superflow Manganese
-  ZYZX Carbon Seatpost
-  ZYZX Alloy Stem
-  ZYZX Mountain Carbon Handlebar

FARBE COLOR  Silver Gray | Cosmos Anthracite | Red

BK29011

RAHMEN FRAME

REVO BOW SL

FEATURES

 39 | 44 | 48 | 52

UVP RRP 6.299 EUR

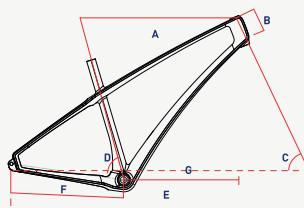

CM	A	B	C	D	E	F	G	H
39	580	95	69	72	1091	425	407	605
44	600	100	69	72	1111	425	425	610
48	625	110	69	72	1137	425	447	619
52	650	121	69	72	1162	425	469	630



Das Rendering dient nur als Referenz
The Rendering is for Reference only

















REVO BOW SL PRO

Das neue Bow Hardtail, extrem steif und gleichzeitig gleichzeitig superleicht. The new Bow Hardtail, extremely stiff and at the same time superlight.

Aufgeräumtes Cockpit mit komplett innenliegenden Zügen. Tidy cockpit with completely internal cables.

Der edle Carbonrahmen bietet beste Dämpfungseigenschaften auf langen Tagestouren. The noble carbon frame offers the best damping properties on long day trips.



-  Revo BOW SL
-  Rock Shox SID SL BASE 2 POS 100MM
-  Shimano Deore XT SGS 12S
-  Shimano SLX
-  Shimano SLX 180mm | Front
-  Shimano SLX 160mm | Rear
-  Shimano, SLX 32T
-  Shimano SLX 12-SPEED 10-51T
-  KMC X12
-  DT Swiss M 1900 Spline® 29" | Front
-  DT Swiss M 1900 Spline® 29" | Rear
-  Schwalbe RACING RAY Evo 29" | Front
-  Schwalbe RACING RALPH Evo 29" | Rear
-  Selle Italia Model X
-  ZZYX Carbon Seatpost
-  ZZYX Alloy Stem
-  ZZYX Mountain Carbon Handlebar

FARBE COLOR



BK29012

RAHMEN FRAME

REVO BOW SL

FEATURES

 39 | 44 | 49 | 54

UVP RRP 3.699 EUR

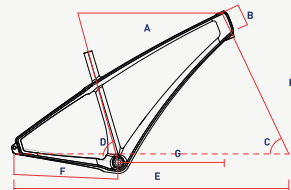

CM	A	B	C	D	E	F	G	H
39	580	95	69	72	1091	425	407	605
44	600	100	69	72	1111	425	425	610
49	625	110	69	72	1137	425	447	619
54	650	121	69	72	1162	425	469	630



Das Rendering dient nur als Referenz
The Rendering is for Reference only

REVO BOW ELITE

Das Fahrrad dient als bestes Trainingsgerät auf XCO-Strecken und ist mit hochwertigen Komponenten ausgestattet. The bike serves as the best training device on XCO routes and is equipped with high-quality components.

Extrem steif dank eines Rahmens aus EPS-Carbon. Extremely stiff thanks to an EPS carbon made frame.

Gewölbtes Oberrohr für mehr Sicherheit und Komfort auf technischen Trails. Arched top tube for increasing safety and comfort on technically trails.



- Revo BOW
- Rock Shox SID SL BASE 2 POS 100MM
- Sram GX Eagle 12S
- Sram GX EAGLE
- Sram Level T 180mm | Front
- Sram Level T 160mm | Rear
- Sram GX EAGLE DUB
- Sram PG1230 EAGLE 11-50T
- CN SX EAGLE 12S
- Mavic Crossmax 29" | Front
- Mavic Crossmax 29" | Rear
- Schwalbe; Nobby Nic Performance Addix 29"x2.25 | Front
- Schwalbe; Nobby Nic Performance Addix 29"x2.25 | Rear
- Selle Italia Model X
- ZZYX Alloy Steapost
- ZZYX Alloy Stem
- ZZYX Mountain Handlebar

FARBE COLOR

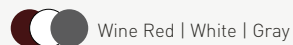

BK29013

RAHMEN FRAME

REVO BOW

39 | 44 | 48 | 52

UVP RRP 2.999 EUR

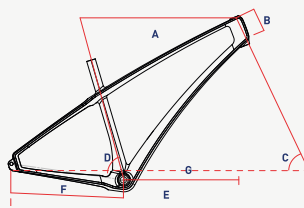

CM	A	B	C	D	E	F	G	H
39	580	95	69	72	1091	425	407	605
44	600	100	69	72	1111	425	425	610
48	625	110	69	72	1137	425	447	619
52	650	121	69	72	1162	425	469	630

FEATURES



Bilder dienen nur als Veranschaulichung
Images are for illustrative purposes only

REVO BOW

Das Fahrrad dient als bestes Trainingsgerät auf XCO-Strecken und ist mit hochwertigen Komponenten ausgestattet. The bike serves as the best training device on XCO routes and is equipped with high-quality components.

Extrem steif dank eines Rahmens aus EPS-Carbon. Super stiff and light EPS carbon frame.

Gewölbtes Oberrohr für mehr Sicherheit und Komfort auf technischen Trails. Arched top tube for increasing safety and comfort on technically trails.



- Revo BOW
- Manitu Markhor 29" 100mm
- Sram SX Eagle 12S
- Sram SX EAGLE
- Sram Level T 180mm | Front
- Sram Level T 160mm | Rear
- Sram SX EAGLE DUB 32T
- Sram PG1210 EAGLE 11-50T
- CN SX EAGLE 12S
- ZZYX Cross-R 29" | Front
- ZZYX Cross-R 29" | Rear
- Schwalbe; Nobby Nic Performance Addix 29"x2.25 | Front
- Schwalbe; Nobby Nic Performance Addix 29"x2.25 | Rear
- Selle Italia Model X
- ZZYX Alloy Steapost
- ZZYX Alloy Stem
- ZZYX Mountain Handlebar

FARBE COLOR

Sky Blue | Red | Anthracite

BK29014

RAHMEN FRAME

REVO BOW

FEATURES

39 | 44 | 49 | 54

UVP RRP 2.499 EUR

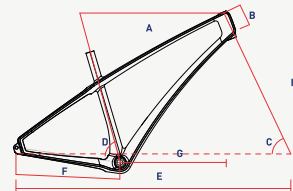

CM	A	B	C	D	E	F	G	H
39	580	95	69	72	1091	425	407	605
44	600	100	69	72	1111	425	425	610
49	625	110	69	72	1137	425	447	619
54	650	121	69	72	1162	425	469	630



Bilder dienen nur als Veranschaulichung
Images are for illustrative purposes only

X VERT PRO TEAM

Der aus hochwertigem Triple Butted Aluminium gefertigte Rahmen besticht durch sein leichtes Gewicht und hohen Steifigkeitswerte. The frame, made of high-quality triple butted aluminum, impresses with its light weight and high rigidity values.

Die sehr ansprechende Optik verleiht dem Rad einen exklusiven Charakter. The very attractive appearance gives the bike an exclusive character.

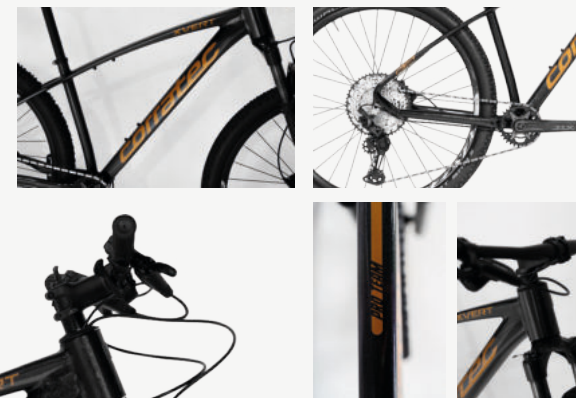

- X Vert 29
- Rockshox FS Recon 29" 100mm
- Shimano Deore XT SGS 12S
- Shimano SLX 12S
- Sram Level T 180mm | Front
- Sram Level T 160mm | Rear
- Shimano SLX 175mm 32T
- Shimano SLX 10-51T 12S
- KMC X12
- ZYZX Cross Attack 29" | Front
- ZYZX Cross Attack 29" | Rear
- Michelin Force 57-622 | Front
- Michelin Force 57-622 | Rear
- Selle X-Base
- ZYZX SL Alloy Seatpost 27.2mm
- ZYZX SL Alloy Stem
- ZYZX SL Alloy Handlebar

FARBE COLOR

Starry Black | Copper

BK29020

RAHMEN FRAME

X VERT 29

FEATURES

39 | 44 | 48 | 52

UVP RRP 1.699 EUR

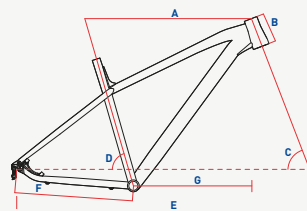

CM	A	B	C	D	E	F	G	H
39	575	91	68	75	1119	442	405	612
44	597	99	68	75	1142	442	425	619
48	625	110	68	75	1171	442	450	629
52	649	121	68	75	1198	442	472	640



Bilder dienen nur als Veranschaulichung
Images are for illustrative purposes only

X VERT PRO

Gefertigt aus hochwertigem Triple Butted Aluminium: Leicht und zugleich extrem steif. Made out of high quality Triple Butted Aluminium – light and stiff at the same time.

Speziell verstärktes Steuerrohr – Tapered Head-tube. Specially reinforced tapered head tube.

Innovative Farbkombinationen, neidische Blicke auf der Alm sind garantiert. Innovative color combinations, envious views of the alp are guaranteed.



Das Rendering dient nur als Referenz
The Rendering is for Reference only

- X Vert 29
- SR Suntour XCR32 Boost 29" 100mm
- SRAM SX 12s
- SRAM SX 12s
- Clarks Clout 180mm | Front
- Clarks Clout 160mm | Rear
- SRAM SX 170 DUB 32T
- SRAM PG1210 12s 11-50T
- SRAM SX 12S
- ZZYX Cross Attack 29" | Front
- ZZYX Cross Attack 29" | Rear
- Continental Race King 29" x 2.2 | Front
- Continental Race King 29" x 2.2 | Rear
- Selle X-Base
- ZZYX SL Alloy Seatpost 27.2mm
- ZZYX SL Alloy Stem
- ZZYX SL Alloy Handlebar

FARBE COLOR Silver Gray | Red

BK29021

RAHMEN FRAME

X VERT 29

FEATURES

39 | 44 | 49 | 54

VVP RRP 1.299 EUR

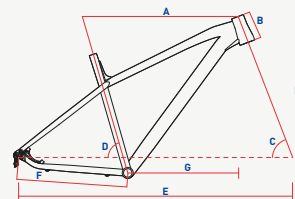

CM	A	B	C	D	E	F	G	H
39	575	91	68	75	1119	442	405	612
44	597	99	68	75	1142	442	425	619
49	625	110	68	75	1171	442	450	629
54	649	121	68	75	1198	442	472	640



X VERT ELITE

Gefertigt aus hochwertigem Triple Butted Aluminium: Leicht und zugleich extrem steif. Made out of high quality Triple Butted Aluminium – light and stiff at the same time.

Speziell verstärktes Steuerrohr – Tapered Head-tube. Specially reinforced tapered head tube.

Innovative Farbkombinationen, neidische Blicke auf der Alm sind garantiert. Innovative color combinations, envious views of the alp are guaranteed.



- 🚲 X Vert 29
- 🔧 SR Suntour XCM RL DS 29" 100mm
- 🔗 L-TWOO A11-X 11S
- 🔗 L-TWOO A11- X
- 🌀 Clarks Clout 180mm I Front
- 🌀 Clarks Clout 160mm I Rear
- 🌀 Lasco 32T
- 🌀 L-TWOO A11 11-42T 11S
- 🔧 KMC X11
- 🌀 ZYZX Cross Attack 29" I Front
- 🌀 ZYZX Cross Attack 29" I Rear
- 🌀 Innova IB-3014 29" x 2.25 I Front
- 🌀 Innova IB-3014 29" x 2.25 I Rear
- 🚲 corratec Sport Saddle
- 🔧 ZYZX SL Alloy Seatpost 27.2mm
- 🔧 ZYZX SL Alloy Stem
- 🚲 ZYZX SL Alloy Handlebar

FARBE COLOR



BK29022

RAHMEN FRAME

X VERT 29

FEATURES

👤 39 | 44 | 48 | 52

UVP RRP 999 EUR

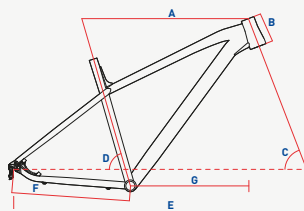

CM	A	B	C	D	E	F	G	H
39	575	91	68	75	1119	442	405	612
44	597	99	68	75	1142	442	425	619
48	625	110	68	75	1171	442	450	629
52	649	121	68	75	1198	442	472	640



Bilder dienen nur als Veranschaulichung
Images are for illustrative purposes only

X VERT EXPERT

Gefertigt aus hochwertigem Triple Butted Aluminium. Made from high quality Triple Butted Aluminium.

Komfortable Geometrie für Sicherheit und Fahrspaß auf langen MTB Touren über Stock und Stein. Comfortable geometry for safety and riding enjoyment on long MTB tours over hill and dale.

Innovative Farbkombinationen, neidische Blicke auf der Alm sind garantiert. Innovative color combinations, envious views of the alp are guaranteed.



- X Vert 29
- HL 525D AMS 29" 100mm
- L-TWOO V5010-LX 10S
- L-TWOO V5010-10W
- Clarks Clout 180mm I Front
- Clarks Clout 160mm I Rear
- Lasco 32T
- L-TWOO A7 11-42T 10S
- KMC X10
- ZZYX Cross Attack 29" I Front
- ZZYX Cross Attack 29" I Rear
- Innova IA-1130 29" x 2.10 I Front
- Innova IA-1130 29" x 2.10 I Rear
- corratec Sport Saddle
- ZZYX SL Alloy Seatpost 30.9mm
- ZZYX SL Alloy Stem
- ZZYX SL Alloy Handlebar

FARBE COLOR

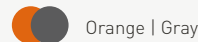

BK29023

RAHMEN FRAME

X VERT 29

FEATURES

39 | 44 | 49 | 54

UVP RRP **849 EUR**

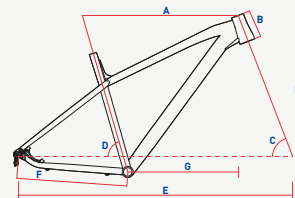

CM	A	B	C	D	E	F	G	H
39	575	95	69	74	1102	450	401	606
44	600	105	69	74	1128	450	424	615
49	625	115	69	74	1154	450	446	625
54	650	125	69	74	1180	450	468	634



Bilder dienen nur als Veranschaulichung
Images are for illustrative purposes only

X VERT MOTION

Gefertigt aus hochwertigem Triple Butted Aluminium. Made from high quality Triple Butted Aluminium.

Komfortable Geometrie für Sicherheit und Fahrspaß auf langen MTB Touren über Stock und Stein. Comfortable geometry for safety and riding enjoyment on long MTB tours over hill and dale.

650B Laufräder extrem wendig – ideal für kleinere Fahrertypen. 650B wheels are extremely flexible –perfectly for smaller bikers.

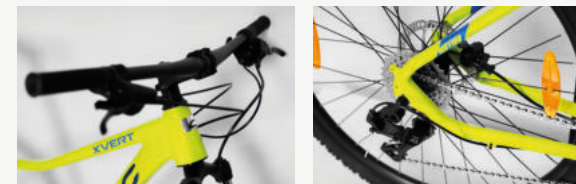

- X Vert 650B
- HL 525D AMS 650B 100mm
- L-TWOO V4008 8S
- L-TWOO V5008
- L-TWOO V4008
- Clarks Clout 180mm | Front
- Clarks Clour 160mm | Rear
- Lasco 22 | 36T
- L-TWOO A3 11-34T 8S
- KMC X8
- ZZYX Cross Attack 650B | Front
- ZZYX Cross Attack 650B | Rear
- Innova IA-1130 27,5" x 2.10 | Front
- Innova IA-1130 27,5" x 2.10 | Rear
- corratec Sport Saddle
- ZZYX SL Alloy Seatpost 27.2mm
- ZZYX SL Alloy Stem
- ZZYX SL Alloy Handlebar

FARBE COLOR



BK29024

RAHMEN FRAME

X VERT 650B

FEATURES

34 | 39 | 44 | 49 | 54

UVP RRP **749 EUR**

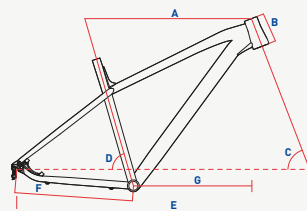

CM	A	B	C	D	E	F	G	H
34	550	100	69	73	1053	438	370	587
39	570	105	69	73	1073	438	389	592
44	590	105	69	73	1093	438	409	592
49	610	115	69	73	1114	438	426	601
54	630	125	69	73	1134	438	443	610



Bilder dienen nur als Veranschaulichung
Images are for illustrative purposes only

X VERT ROCK TEAM

Das perfekte Bike für alle Einsteiger und angehenden MTB Stars. The perfect bike for all beginners and upcoming MTB Stars.

Der Hauptzweck der X Vert Young Series ist vor allem ist die Freude am Radfahren. Above all the main purpose of the X Vert Young Series is the joy of riding your bike.

Dank der hochwertigen Ausstattung ist dieses stylische Bike alles andere als ein herkömmliches Kinderfahrrad. Thanks to high-quality equipment, this stylish bike is anything but a conventional children's bike.

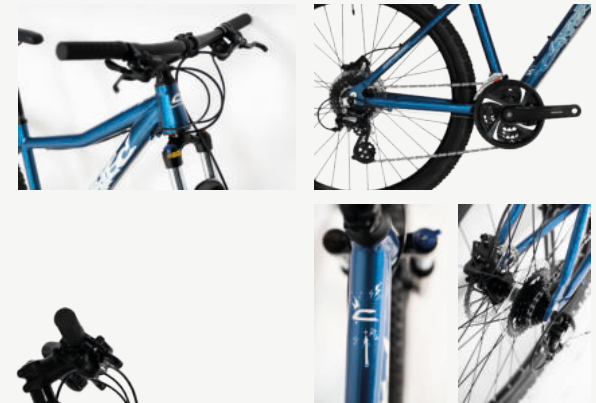

XVERT

- 🚲 X Vert 26
- 🔧 SR Suntour XCE28 DS 26" 100mm
- 🔧 Shimano Altus 8s
- 🔧 Shimano Tourney
- 🔧 Shimano M315 8s
- 🔧 Clarks Clout 180 mm | Front
- 🔧 Clarks Clout 160 mm | Rear
- 🔧 Shimano Tourney 42 | 32 | 22T
- 🔧 Shimano CS-HG31 11-34T 8s
- 🔧 KMC X8
- 🔧 ZZYX Cross Attack 26" | Front
- 🔧 ZZYX Cross Attack 26" | Rear
- 🔧 Rubena Ocelot 26" x 2.10 | Front
- 🔧 Rubena Ocelot 26" x 2.10 | Rear
- 🔧 Selle Italia X-Base
- 🔧 ZZYX SL Alloy Seatpost 27.2mm
- 🔧 ZZYX SL Alloy Stem
- 🔧 ZZYX SL Alloy Handlebar

FARBE COLOR



BK29030

RAHMEN FRAME

X VERT 26

FEATURES

👤 34 | 39

UVP RRP **689 EUR**

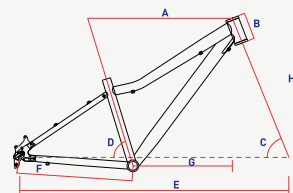

CM	A	B	C	D	E	F	G	H
34	530	100	69	73	1021	420	366	568
39	540	100	69	73	1031	420	367	568



Bilder dienen nur als Veranschaulichung
Images are for illustrative purposes only

X VERT ROCK

Das perfekte Bike für alle Einsteiger und angehenden MTB Stars. The perfect bike for all beginners and upcoming MTB Stars.

Der Hauptzweck der X Vert Young Series ist vor allem ist die Freude am Radfahren. Above all the main purpose of the X Vert Young Series is the joy of riding your bike.

Dank der hochwertigen Ausstattung ist dieses stylische Bike alles andere als ein herkömmliches Kinderfahrrad. Thanks to high-quality equipment, this stylish bike is anything but a conventional children's bike.



- 🚲 X Vert 26
- 🚲 SR Suntour XCE28 DS 26" 100mm
- 🚲 Shimano Tourney 8s
- 🚲 Shimano Tourney
- 🚲 Shimano Tourney 8s
- 🚲 Clarks CMD 23 160 mm | Front
- 🚲 Clarks CMD 23 160 mm | Rear
- 🚲 Shimano TY501 165 mm 42 | 34 | 24T
- 🚲 G. Falcon CS-852 11-32T 8s
- 🚲 KMC X8
- 🚲 ZZYX Cross Attack 26" | Front
- 🚲 ZZYX Cross Attack 26" | Rear
- 🚲 Rubena Ocelot 26" x 2.10 | Front
- 🚲 Rubena Ocelot 26" x 2.10 | Rear
- 🚲 Selle Italia X-Base
- 🚲 ZZYX SL Alloy Seatpost 27.2mm
- 🚲 ZZYX SL Alloy Stem
- 🚲 ZZYX SL Alloy Handlebar

FARBE COLOR



BK29031

RAHMEN FRAME

X VERT 26

FEATURES

👤 34 | 39

UVP RRP 599 EUR

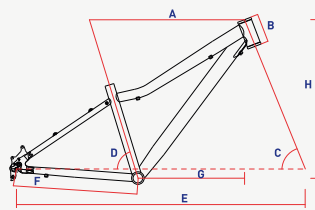

CM	A	B	C	D	E	F	G	H
34	530	100	69	73	1021	420	366	568
39	540	100	69	73	1031	420	367	568



Bilder dienen nur als Veranschaulichung
Images are for illustrative purposes only

X VERT TEEN

Das ideale Rad für den Einstieg in die Welt des Mountainbikens. The perfect bike for all beginners and upcoming MTB stars.

Das Bike vermittelt vor allem Eines: Freude am Fahren. Above all the main purpose of the X Vert Young Series is the joy of riding your bike.



XVERT

Das Rendering dient nur als Referenz
The Rendering is for Reference only

- X Vert Kid 24"
- ZZYX Select 24" 50mm
- Shimano Tourney 7S
- Shimano Altus
- ZZYX V-Brake
- ZZYX V-Brake
- Shimano Crankset 35T
- Shimano TZ500 14-28T
- KMC HV-500
- ZZYX Cross Attack 20"
- ZZYX Cross Country 20"
- ZZYX Youth Saddle
- ZZYX SL Alloy Seatpost
- ZZYX SL Alloy Stem
- ZZYX SL Alloy Handlebar

FARBE COLOR

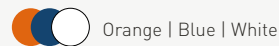

BK29032

RAHMEN FRAME

X VERT 24

FEATURES

UNI

UVP RRP 499 EUR

CM	A	B	C	D	E	F	G	H
31	510	105	69	71	950	415	336	505

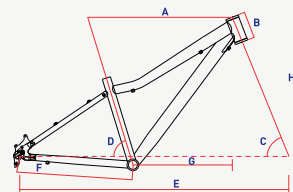





X VERT KID

Das ideale Rad für den Einstieg in die Welt des Mountainbikens. The perfect bike for all beginners and upcoming MTB stars.

Das Bike vermittelt vor allem Eines: Freude am Fahren. Above all the main purpose of the X Vert Young Series is the joy of riding your bike.



-  X Vert Kid 20"
-  ZZYX Select 20" 30mm
-  Shimano Tourney 7S
-  Shimano Tourney 7S
-  ZZYX V-Brake
-  ZZYX V-Brake
-  Shimano Crankset 35T
-  Shimano TZ500 14-28T
-  KMC HV-500
-  ZZYX Cross Attack 20"
-  ZZYX Cross Country 20"
-  ZZYX Youth Saddle
-  ZZYX SL Alloy Seatpost
-  ZZYX SL Alloy Stem
-  ZZYX SL Alloy Handlebar

FARBE COLOR

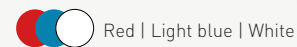
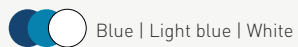

BK29033

RAHMEN FRAME

X VERT 20

FEATURES

 UNI

UVP RRP 399 EUR

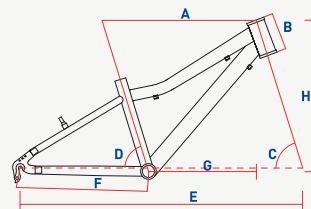

CM	A	B	C	D	E	F	G	H
27	430	105	70	73	851	360	299	424



Das Rendering dient nur als Referenz
The Rendering is for Reference only



THE TREKKINGBIKE

Die speziell für diesen Einsatzbereich abgestimmte Geometrie der Trekkingräder garantiert Dir ein ergonomisches Fahren. Hochwertige Komponenten und eine stylische Optik runden das gesamte Komfortpaket ab und verleihen der corratec City & Trekking Range einen exklusiven Charakter.

The geometry of the trekking bikes are specially developed for urban as well as trekking rides across stick and stone. In addition the City & Trekking bikes of corratec combines high quality components and stylish designs. These features provide the corratec bikes of the category City & Trekking with an exclusive character.







C29 ELITE SPORT

Die Premium Klasse unter den Trekking Bikes.
Die Premium Klasse unter den Trekking Bikes.

Das urbane Rad bietet mit der 29 Zoll Bereifung höchstmögliche Dämpfung und ideale Rolleigenschaften. With its 29 inch tires, the urban bike offers the highest possible damping and ideal rolling properties.

Die ergonomische Geometrie des Rahmens und der verbaute Speedlifter garantieren Dir maximalen Komfort. The ergonomic geometry of the frame and the built-in speedlifter ensures maximum comfort.

-  corrateg C29
-  C29er Alloy Fork
-  Shimano Deore XT 10S
-  Shimano Deore
-  Shimano Deore 10S
-  CLARKS M2, 2-Piston 180mm I Front
-  CLARKS M2, 2-Piston 160mm I Rear
-  Shimano Deore 48 I 36 I 26T
-  Shimano CS-HG50 11-36T 10S
-  KMC X10
-  ZYZX 29er Disc I Front
-  ZYZX 29er Disc I Rear
-  Continental Contact Cruiser 55-622 I Front
-  Continental Contact Cruiser 55-622 I Rear
-  corrateg Classic Leather Saddle
-  ZYZX SL Alloy Seatpost 27.2mm
-  ZYZX Speedlifter
-  ZYZX Trekking Handlebar



Das Rendering dient nur als Referenz
The Rendering is for Reference only

FARBE COLOR

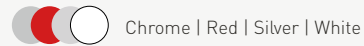

BK29200

RAHMEN FRAME

CORRATEC C29 SPORT

FEATURES

 45 | 48 | 51 | 54

UVP RRP **1.499 €**

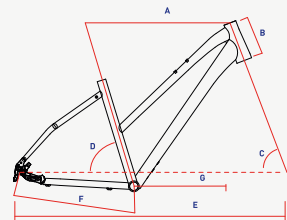

CM	A	B	C	D	E	F	G	H
45	578	155	69	73	1103	465	398	589
48	591	155	69	73	1116	465	411	589
51	599	190	69	73	1120	465	402	622
54	608	190	69	73	1129	465	402	622



















C29 ELITE GENT

Dein idealer Begleiter zur täglichen Fahrt in die Arbeit oder für sportliche Ausfahrten. Your ideal companion for the daily ride to work or for sporty rides.

Das urbane Rad bietet mit der 29 Zoll Bereifung höchstmögliche Dämpfung und ideale Rolleigenschaften. With its 29 inch tires, the urban bike offers the highest possible damping and ideal rolling properties.

Die ergonomische Geometrie des Rahmens und der verbaute Speedlifter garantieren Dir maximalen Komfort. The ergonomic geometry of the frame and the built-in speedlifter ensures maximum comfort.

-  corratec C29
-  C29er Alloy Fork
-  Shimano Deore XT 10S
-  Shimano Deore
-  Shimano Deore 10S
-  CLARKS M2, 2-Piston 180mm | Front
-  CLARKS M2, 2-Piston 160mm | Rear
-  Shimano Deore 48 | 36 | 26T
-  Shimano CS-HG50 11-36T 10S
-  KMC X10
-  ZYZX 29er Disc | Front
-  ZYZX 29er Disc | Rear
-  Continental Contact Cruiser 55-622 | Front
-  Continental Contact Cruiser 55-622 | Rear
-  corratec Classic Leather Saddle
-  ZYZX SL Alloy Seatpost 27.2mm
-  ZYZX Speedlifter
-  ZYZX Trekking Handlebar



Das Rendering dient nur als Referenz
The Rendering is for Reference only

FARBE COLOR

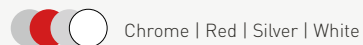

BK29201

RAHMEN FRAME

CORRATEC C29 GENT

FEATURES

 48 | 51 | 54 | 57 | 61

UVP RRP 1.499 €

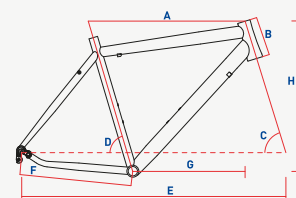

CM	A	B	C	D	E	F	G	H
48	580	140	69	73	1116	465	404	575
51	587	155	69	73	1106	465	401	589
54	596	170	69	73	1116	465	406	603
57	610	185	69	73	1132	465	416	617
61	622	200	69	73	1145	465	423	631



















C29 BASE SPORT

Dein idealer Begleiter zur täglichen Fahrt in die Arbeit oder für sportliche Ausfahrten. Your ideal companion for the daily ride to work or for sporty rides.

Das urbane Rad bietet mit der 29 Zoll Bereifung höchstmögliche Dämpfung und ideale Rolleigenschaften. With its 29 inch tires, the urban bike offers the highest possible damping and ideal rolling properties.

Die ergonomische Geometrie des Rahmens und der verbaute Speedlifter garantieren Dir maximalen Komfort. The ergonomic geometry of the frame and the built-in speedlifter ensures maximum comfort.

-  corrateg C29
-  C29er Alloy Fork
-  Shimano Alfi ne 8S
-  Shimano Alfi ne 8S
-  CLARKS M2, 2-Piston 180mm I Front
-  CLARKS M2, 2-Piston 160mm I Rear
-  Miranda 38T
-  Shimano CS-S500 Alfi ne 18T 8S
-  KMC X8
-  ZZYX 29er Disc I Front
-  ZZYX 29er Disc I Rear
-  Continental Contact Cruiser 55-622 I Front
-  Continental Contact Cruiser 55-622 I Rear
-  corrateg Classic Leather Saddle
-  ZZYX SL Alloy Seatpost 27.2mm
-  ZZYX Speedlifter
-  ZZYX Trekking Handlebar

MORE INFORMATION COMING SOON...

2024

C29er

Das Rendering dient nur als Referenz
The Rendering is for Reference only

FARBE COLOR

 Dark brown | Gold | Silver | Pearlized Black

BK29202

RAHMEN FRAME

CORRATEC C29 SPORT

FEATURES

 45 | 48 | 51 | 54

UVP RRP 1.299 €

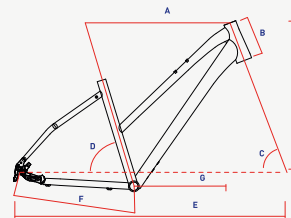

CM	A	B	C	D	E	F	G	H
45	578	155	69	73	1103	465	398	589
48	591	155	69	73	1116	465	411	589
51	599	190	69	73	1120	465	402	622
54	608	190	69	73	1129	465	402	622



















C29 BASE GENT

Dein idealer Begleiter zur täglichen Fahrt in die Arbeit oder für sportliche Ausfahrten. Your ideal companion for the daily ride to work or for sporty rides.

Das urbane Rad bietet mit der 29 Zoll Bereifung höchstmögliche Dämpfung und ideale Rolleigenschaften. With its 29 inch tires, the urban bike offers the highest possible damping and ideal rolling properties.

Die ergonomische Geometrie des Rahmens und der verbaute Speedlifter garantieren Dir maximalen Komfort. The ergonomic geometry of the frame and the built-in speedlifter ensures maximum comfort.

-  corratec C29
-  C29er Alloy Fork
-  Shimano Alfi ne 8S
-  Shimano Alfi ne 8S
-  CLARKS M2, 2-Piston 180mm | Front
-  CLARKS M2, 2-Piston 160mm | Rear
-  Miranda 38T
-  Shimano CS-S500 Alfi ne 18T 8S
-  KMC X8
-  ZZYX 29er Disc | Front
-  ZZYX 29er Disc | Rear
-  Continental Contact Cruiser 55-622 | Front
-  Continental Contact Cruiser 55-622 | Rear
-  corratec Classic Leather Saddle
-  ZZYX SL Alloy Seatpost 27.2mm
-  ZZYX Speedlifter
-  ZZYX Trekking Handlebar



C29er

Das Rendering dient nur als Referenz
The Rendering is for Reference only

FARBE COLOR

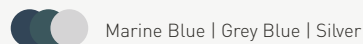

BK29203

RAHMEN FRAME

CORRATEC C29 GENT

FEATURES

 48 | 51 | 54 | 57 | 61

UVP RRP 1.299 €

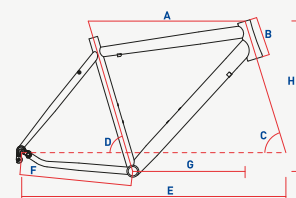

CM	A	B	C	D	E	F	G	H
48	580	140	69	73	1116	465	404	575
51	587	155	69	73	1106	465	401	589
54	596	170	69	73	1116	465	406	603
57	610	185	69	73	1132	465	416	617
61	622	200	69	73	1145	465	423	631



MTC ELITE SPORT

Das Mountaincrossbike ist nun auch als Bio Bike erhältlich. The mountain cross bike is now also available as a bio bike.

Mit 29 Zoll Mountainbike Bereifung ist das Bike für jeden Untergrund die perfekte Wahl. With 29 inch mountain bike tires, the bike is the perfect choice for every surface.

Eine bereits installierte Lichtanlage bietet zusätzliche Sicherheit im Straßenverkehr. An already installed light system offers additional safety in road traffic.



- corratec MTC
- SR Suntour XCM LO DS 29" 80mm
- Shimano Deore XT 10S
- Shimano Deore
- Shimano Deore 10S
- CLARKS M2, 2-Piston 180mm I Front
- CLARKS M2, 2-Piston 160mm I Rear
- Shimano Deore 48 I 36 I 26T
- Shimano CS-HG50 11-36T 10S
- KMC X10
- ZYZX 29er Disc I Front
- ZYZX 29er Disc I Rear
- Schwalbe Smart Sam 57-622 I Front
- Schwalbe Smart Sam 57-622 I Rear
- corratec Comfort Saddle
- ZYZX SL Alloy Seatpost 27.2mm
- ZYZX SL Alloy Stem
- ZYZX Trekking Handlebar

FARBE COLOR



BK29210

39 | 44 | 49 | 54

UVP RRP 1.299 €

RAHMEN FRAME

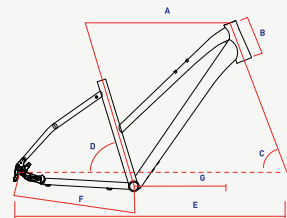

CORRATEC MTC SPORT

CM	A	B	C	D	E	F	G	H
39	570	155	69	73	1105	460	373	644
44	580	160	69	73	1116	460	382	649
49	595	160	69	73	1131	460	397	649
54	615	160	69	73	1131	460	417	649

FEATURES



Das Rendering dient nur als Referenz
The Rendering is for Reference only

MTC ELITE GENT

Das Mountaincrossbike ist nun auch als Bio Bike erhältlich. The mountain cross bike is now also available as a bio bike.

Mit 29 Zoll Mountainbike Bereifung ist das Bike für jeden Untergrund die perfekte Wahl. With 29 inch mountain bike tires, the bike is the perfect choice for every surface.

Eine bereits installierte Lichtanlage bietet zusätzliche Sicherheit im Straßenverkehr. An already installed light system offers additional safety in road traffic.

-  corratec MTC
-  SR Suntour XCM LO DS 29" 80mm
-  Shimano Deore XT 10S
-  Shimano Deore
-  Shimano Deore 10S
-  CLARKS M2, 2-Piston 180mm I Front
-  CLARKS M2, 2-Piston 160mm I Rear
-  Shimano Deore 48 I 36 I 26T
-  Shimano CS-HG50 11-36T 10S
-  KMC X10
-  ZYZX 29er Disc I Front
-  ZYZX 29er Disc I Rear
-  Schwalbe Smart Sam 57-622 I Front
-  Schwalbe Smart Sam 57-622 I Rear
-  corratec Comfort Saddle
-  ZYZX SL Alloy Seatpost 27.2mm
-  ZYZX SL Alloy Stem
-  ZYZX Trekking Handlebar



Das Rendering dient nur als Referenz
The Rendering is for Reference only

FARBE COLOR



BK29211

 44 | 49 | 54 | 57

UVP RRP 1.299 €

RAHMEN FRAME

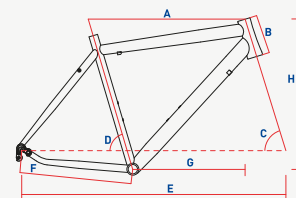

CORRATEC MTC GENT

CM	A	B	C	D	E	F	G	H
44	570	155	69	73	1105	460	373	644
49	580	160	69	73	1116	460	382	649
54	595	160	69	73	1131	460	397	649
57	615	160	69	73	1131	460	417	649

FEATURES



MTC EXPERT SPORT

Das Mountaincrossbike ist nun auch als Bio Bike erhältlich. The mountain cross bike is now also available as a bio bike.

Mit 29 Zoll Mountainbike Bereifung ist das Bike für jeden Untergrund die perfekte Wahl. With 29 inch mountain bike tires, the bike is the perfect choice for every surface.

Eine bereits installierte Lichtanlage bietet zusätzliche Sicherheit im Straßenverkehr. An already installed light system offers additional safety in road traffic.



- corratec MTC
- SR Suntour XCM LO DS 29" 80mm
- Shimano Alivio 9S
- Shimano Acera
- Shimano Altus 9S
- CLARKS M2, 2-Piston 180mm I Front
- CLARKS M2, 2-Piston 160mm I Rear
- Shimano FC-MT210 46 I 30T
- Shimano CS-HG200 11-36T 9S
- KMC X9
- ZZYX 29er Disc I Front
- ZZYX 29er Disc I Rear
- Schwalbe Smart Sam 57-622 I Front
- Schwalbe Smart Sam 57-622 I Rear
- corratec Comfort Saddle
- ZZYX SL Alloy Seatpost 27.2mm
- ZZYX SL Alloy Stem
- ZZYX Trekking Handlebar

FARBE COLOR



Light Blue Silver | Orange | Brilliant Petrol

BK29212

RAHMEN FRAME

CORRATEC MTC SPORT

FEATURES

39 | 44 | 49 | 54

UVP RRP **999 €**

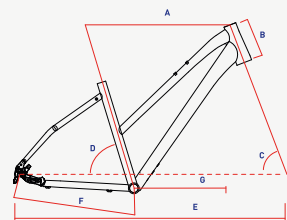

CM	A	B	C	D	E	F	G	H
39	570	155	69	73	1105	460	373	644
44	580	160	69	73	1116	460	382	649
49	595	160	69	73	1131	460	397	649
54	615	160	69	73	1131	460	417	649



Das Rendering dient nur als Referenz
The Rendering is for Reference only

MTC EXERT GENT

Das Mountaincrossbike ist nun auch als Bio Bike erhältlich. The mountain cross bike is now also available as a bio bike.

Mit 29 Zoll Mountainbike Bereifung ist das Bike für jeden Untergrund die perfekte Wahl. With 29 inch mountain bike tires, the bike is the perfect choice for every surface.

Eine bereits installierte Lichtanlage bietet zusätzliche Sicherheit im Straßenverkehr. An already installed light system offers additional safety in road traffic.



- corratec MTC
- SR Suntour XCM LO DS 29" 80mm
- Shimano Alivio 9S
- Shimano Acera
- Shimano Altus 9S
- CLARKS M2, 2-Piston 180mm | Front
- CLARKS M2, 2-Piston 160mm | Rear
- Shimano FC-MT210 46 | 30T
- Shimano CS-HG200 11-36T 9S
- KMC X9
- ZYZX 29er Disc | Front
- ZYZX 29er Disc | Rear
- Schwalbe Smart Sam 57-622 | Front
- Schwalbe Smart Sam 57-622 | Rear
- corratec Comfort Saddle
- ZYZX SL Alloy Seatpost 27.2mm
- ZYZX SL Alloy Stem
- ZYZX Trekking Handlebar

FARBE COLOR



BK29213

44 | 49 | 54 | 57

UVP RRP 999 €

RAHMEN FRAME

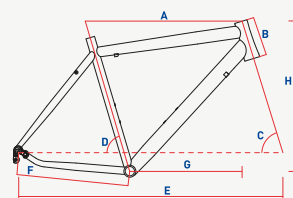

CORRATEC MTC GENT

CM	A	B	C	D	E	F	G	H
44	570	155	69	73	1105	460	373	644
49	580	160	69	73	1116	460	382	649
54	595	160	69	73	1131	460	397	649
57	615	160	69	73	1131	460	417	649

FEATURES



Das Rendering dient nur als Referenz
The Rendering is for Reference only

MTC BASE SPORT

Das Mountaincrossbike ist nun auch als Bio Bike erhältlich. The mountain cross bike is now also available as a bio bike.

Mit 29 Zoll Mountainbike Bereifung ist das Bike für jeden Untergrund die perfekte Wahl. With 29 inch mountain bike tires, the bike is the perfect choice for every surface.

Eine bereits installierte Lichtanlage bietet zusätzliche Sicherheit im Straßenverkehr. An already installed light system offers additional safety in road traffic.



- corratec MTC
- SR Suntour XCM LO DS 29" 80mm
- Shimano Alfi ne 8S
- Shimano Alfi ne 8S
- CLARKS M2, 2-Piston 180mm I Front
- CLARKS M2, 2-Piston 160mm I Rear
- Miranda 38T
- Shimano CS-S500 Alfi ne 18T 8S
- KMC X8
- ZZZZX 29er Disc I Front
- ZZZZX 29er Disc I Rear
- Schwalbe Smart Sam 57-622 I Front
- Schwalbe Smart Sam 57-622 I Rear
- corratec Comfort Saddle
- ZZZZX SL Alloy Seatpost 27.2mm
- ZZZZX SL Alloy Stem
- ZZZZX Trekking Handlebar

FARBE COLOR



BK29214

RAHMEN FRAME

CORRATEC MTC SPORT

FEATURES

39 | 44 | 49 | 54

UVP RRP 1.099 €

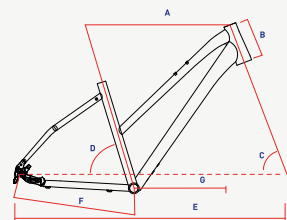

CM	A	B	C	D	E	F	G	H
39	570	155	69	73	1105	460	373	644
44	580	160	69	73	1116	460	382	649
49	595	160	69	73	1131	460	397	649
54	615	160	69	73	1131	460	417	649



Das Rendering dient nur als Referenz
The Rendering is for Reference only

MTC BASE GENT

Das Mountaincrossbike ist nun auch als Bio Bike erhältlich. The mountain cross bike is now also available as a bio bike.

Mit 29 Zoll Mountainbike Bereifung ist das Bike für jeden Untergrund die perfekte Wahl. With 29 inch mountain bike tires, the bike is the perfect choice for every surface.

Eine bereits installierte Lichtanlage bietet zusätzliche Sicherheit im Straßenverkehr. An already installed light system offers additional safety in road traffic.



-  corratec MTC
-  SR Suntour XCM LO DS 29" 80mm
-  Shimano Alfi ne 8S
-  Shimano Alfi ne 8S
-  CLARKS M2, 2-Piston 180mm | Front
-  CLARKS M2, 2-Piston 160mm | Rear
-  Miranda 38T
-  Shimano CS-S500 Alfi ne 18T 8S
-  KMC X8
-  ZYZX 29er Disc | Front
-  ZYZX 29er Disc | Rear
-  Schwalbe Smart Sam 57-622 | Front
-  Schwalbe Smart Sam 57-622 | Rear
-  corratec Comfort Saddle
-  ZYZX SL Alloy Seatpost 27.2mm
-  ZYZX SL Alloy Stem
-  ZYZX Trekking Handlebar

FARBE COLOR

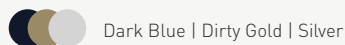

BK29215

RAHMEN FRAME

CORRATEC MTC GENT

FEATURES

 44 | 49 | 54 | 57

UVP RRP 1.099 €

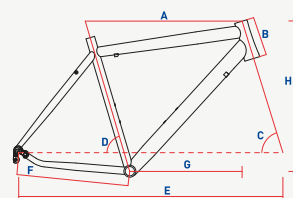

CM	A	B	C	D	E	F	G	H
44	570	155	69	73	1105	460	373	644
49	580	160	69	73	1116	460	382	649
54	595	160	69	73	1131	460	397	649
57	615	160	69	73	1131	460	417	649



Das Rendering dient nur als Referenz
The Rendering is for Reference only



corrateg
PASSION OF CYCLING